

Pioneer

AV Receiver

VSX-1029-K

VSX-824-K

Register your product on

<http://www.pioneerelectronics.com> (US)

<http://www.pioneerelectronics.ca> (Canada)

- **Protect your new investment**

The details of your purchase will be on file for reference in the event of an insurance claim such as loss or theft.

- **Receive free tips, updates and service bulletins on your new product**

- **Improve product development**

Your input helps us continue to design products that meet your needs.

- **Receive a free Pioneer newsletter**

Registered customers can opt in to receive a monthly newsletter.

Operating Instructions

IMPORTANT



The lightning flash with arrowhead symbol, within an equilateral triangle, is intended to alert the user to the presence of uninsulated "dangerous voltage" within the product's enclosure that may be of sufficient magnitude to constitute a risk of electric shock to persons.

CAUTION

**RISK OF ELECTRIC SHOCK
DO NOT OPEN**

CAUTION:
TO PREVENT THE RISK OF ELECTRIC SHOCK, DO NOT REMOVE COVER (OR BACK). NO USER-SERVICEABLE PARTS INSIDE. REFER SERVICING TO QUALIFIED SERVICE PERSONNEL.



The exclamation point within an equilateral triangle is intended to alert the user to the presence of important operating and maintenance (servicing) instructions in the literature accompanying the appliance.

D3-4-2-1-1b_A1_En

NOTE:

This equipment has been tested and found to comply with the limits for a Class B digital device, pursuant to Part 15 of the FCC Rules. These limits are designed to provide reasonable protection against harmful interference in a residential installation. This equipment generates, uses, and can radiate radio frequency energy and, if not installed and used in accordance with the instructions, may cause harmful interference to radio communications. However, there is no guarantee that interference will not occur in a particular installation. If this equipment does cause harmful interference to radio or television reception, which can be determined by turning the equipment off and on, the user is encouraged to try to correct the interference by one or more of the following measures:

- Reorient or relocate the receiving antenna.
- Increase the separation between the equipment and receiver.
- Connect the equipment into an outlet on a circuit different from that to which the receiver is connected.
- Consult the dealer or an experienced radio/TV technician for help.

D8-10-1-2_A1_En

Information to User

Alterations or modifications carried out without appropriate authorization may invalidate the user's right to operate the equipment.

D8-10-2_A1_En

WARNING

This equipment is not waterproof. To prevent a fire or shock hazard, do not place any container filled with liquid near this equipment (such as a vase or flower pot) or expose it to dripping, splashing, rain or moisture.

D3-4-2-1-3_A1_En

WARNING

To prevent a fire hazard, do not place any naked flame sources (such as a lighted candle) on the equipment.

D3-4-2-1-7a_A1_En

(Symbol examples for batteries)

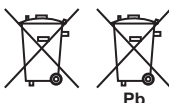

These symbols are only valid in the European Union.

K058c_A1_En

WARNING

Store small parts out of the reach of children and infants. If accidentally swallowed, contact a doctor immediately.

D41-6-4_A1_En

VENTILATION CAUTION

When installing this unit, make sure to leave space around the unit for ventilation to improve heat radiation (at least 40 cm at top, 20 cm at rear, and 20 cm at each side).

WARNING

Slots and openings in the cabinet are provided for ventilation to ensure reliable operation of the product, and to protect it from overheating. To prevent fire hazard, the openings should never be blocked or covered with items (such as newspapers, table-cloths, curtains) or by operating the equipment on thick carpet or a bed.

D3-4-2-1-7b*_A1_En

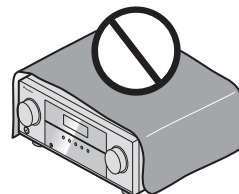

Operating Environment

Operating environment temperature and humidity:
+5 °C to +35 °C (+41 °F to +95 °F); less than 85 %RH (cooling vents not blocked)

Do not install this unit in a poorly ventilated area, or in locations exposed to high humidity or direct sunlight (or strong artificial light).

D3-4-2-1-7c*_A2_En

Caution

To prevent fire hazard, the Class 2 Wiring Cable should be used for connection with speaker, and should be routed away from hazards to avoid damage to the insulation of the cable.

D3-7-13-67*_A1_En

This product is for general household purposes. Any failure due to use for other than household purposes (such as long-term use for business purposes in a restaurant or use in a car or ship) and which requires repair will be charged for even during the warranty period.

K041_A1_En

IMPORTANT SAFETY INSTRUCTIONS

- 1) Read these instructions.
- 2) Keep these instructions.
- 3) Heed all warnings.
- 4) Follow all instructions.
- 5) Do not use this apparatus near water.
- 6) Clean only with dry cloth.
- 7) Do not block any ventilation openings. Install in accordance with the manufacturer's instructions.
- 8) Do not install near any heat sources such as radiators, heat registers, stoves, or other apparatus (including amplifiers) that produce heat.
- 9) Do not defeat the safety purpose of the polarized or grounding-type plug. A polarized plug has two blades with one wider than the other. A grounding type plug has two blades and a third grounding prong. The wide blade or the third prong are provided for your safety. If the provided plug does not fit into your outlet, consult an electrician for replacement of the obsolete outlet.
- 10) Protect the power cord from being walked on or pinched particularly at plugs, convenience receptacles, and the point where they exit from the apparatus.

D3-7-13-69_En

- 11) Only use attachments/accessories specified by the manufacturer.
- 12) Use only with the cart, stand, tripod, bracket, or table specified by the manufacturer, or sold with the apparatus. When a cart is used, use caution when moving the cart/apparatus combination to avoid injury from tip-over.



- 13) Unplug this apparatus during lightning storms or when unused for long periods of time.
- 14) Refer all servicing to qualified service personnel. Servicing is required when the apparatus has been damaged in any way, such as power-supply cord or plug is damaged, liquid has been spilled or objects have fallen into the apparatus, the apparatus has been exposed to rain or moisture, does not operate normally, or has been dropped.

CAUTION

This product satisfies FCC regulations when shielded cables and connectors are used to connect the unit to other equipment. To prevent electromagnetic interference with electric appliances such as radios and televisions, use shielded cables and connectors for connections.

D8-10-3a_A1_En

IMPORTANT NOTICE

THE MODEL NUMBER AND SERIAL NUMBER OF THIS EQUIPMENT ARE ON THE REAR OR BOTTOM. RECORD THESE NUMBERS ON YOUR ENCLOSED WARRANTY CARD AND KEEP IN A SAFE PLACE FOR FUTURE REFERENCE.

D36-AP9-1_A1_En

WARNING: Handling the cord on this product or cords associated with accessories sold with the product may expose you to chemicals listed on proposition 65 known to the State of California and other governmental entities to cause cancer and birth defect or other reproductive harm.

Wash hands after handling.

D36-P5_B1_En

CAUTION

The **⏻** **STANDBY/ON** switch on this unit will not completely shut off all power from the AC outlet. Since the power cord serves as the main disconnect device for the unit, you will need to unplug it from the AC outlet to shut down all power. Therefore, make sure the unit has been installed so that the power cord can be easily unplugged from the AC outlet in case of an accident. To avoid fire hazard, the power cord should also be unplugged from the AC outlet when left unused for a long period of time (for example, when on vacation).

D3-4-2-2a*_A1_En

Contents

Thank you for buying this Pioneer product. Please read through these operating instructions so you will know how to operate your model properly.

Features	6
Before you start	8
Checking what's in the box	8
Installing the receiver	8
Flow of settings on the receiver	8
01 Controls and displays	
Front panel	9
Display	10
Remote control	11
Loading the batteries	12
Operating range of remote control	13
02 Connecting your equipment	
Determining the speakers' application	14
Some tips for improving sound quality	15
Connecting the speakers	15
Connect the surround back or front height speakers (VSX-1029 only)	16
Switching the speaker terminal	18
Making cable connections	18
HDMI cables	18
About HDMI	18
Analog audio cables	19
Digital audio cables	19
Video cables	19
About video outputs connection	19
Connecting a TV and playback components	20
Connecting using HDMI	20
Connecting your TV with no HDMI input	21
Connecting optional <i>Bluetooth</i> [®] ADAPTER	22
Connecting to the network through LAN interface	22
Connecting to a wireless LAN	22
Connecting antennas	23
Using external antennas	23
Connecting an IR receiver (VSX-1029 only)	24
Connecting an iPod	24
Connecting a USB device	24
Connecting a MHL-compatible device	25
Enjoy Roku video streaming service	25

Connecting an HDMI-equipped component to the front panel input	25
Plugging in the receiver	25
03 Basic Setup	
Automatically setting up for surround sound (MCACC) ..	26
Other problems when using the Auto MCACC setup ..	27
04 Basic playback	
Playing a source	28
Selecting the audio input signal	28
Playing an iPod	30
Playing back files stored on an iPod	31
Basic playback controls	31
Switches between the iPod controls and the receiver controls	31
Playing a USB device	31
Playing back audio files stored on a USB memory device	32
Playing back photo files stored on a USB memory device	32
About playable file formats	32
Playing a MHL-compatible device	33
Enjoy Roku video streaming service	33
<i>Bluetooth</i> [®] ADAPTER for Wireless Enjoyment of Music	34
Wireless music play	34
Pairing the <i>Bluetooth</i> ADAPTER and <i>Bluetooth</i> wireless technology device	34
Listening to Music Contents of <i>Bluetooth</i> wireless technology device with Your System	35
Listening to the radio	36
Improving FM sound	36
Saving station presets	36
Listening to station presets	36
Naming preset stations	36
05 Listening to your system	
Choosing the listening mode	37
Auto playback	37
Listening in surround sound	37
Using the Advanced surround	38
Using Stream Direct	38
Using the Sound Retriever	38
Listening with Acoustic Calibration EQ	38

Using surround back channel processing (VSX-1029 only)	38
Setting the Up Mix function (VSX-1029 only)	39
Setting the Audio options	39
06 Playback with NETWORK features	
Introduction	42
About playable DLNA network devices	42
Using AirPlay on iPod touch, iPhone, iPad, and iTunes	42
About the DHCP server function	42
Authorizing this receiver	42
About HTC Connect	43
Playback with Network functions	43
Basic playback controls	43
Listening to Internet radio stations	44
Listening to Pandora Internet Radio	44
About the Spotify audio stream playback function	45
Preparations (1) Installing the Spotify application on mobile digital devices and registering a Spotify Premium account	45
Preparations (2) Connecting this unit to the network ..	45
In order to use the Spotify audio stream playback function from the Spotify application	45
Playing back audio files stored on components on the network	45
Playing back your favorite songs	45
The Network Setup menu	46
Network Configuration	46
Language	47
Firmware Update	47
Network setting using Safari browser	48
Friendly Name setting using Safari browser	48
Firmware update using Safari browser	48
Factory Reset	49
System Information	49
About network playback	50
Content playable over a network	50
About playback behavior over a network	50
Glossary	51
About playable file formats	51
07 Home Menu	
Using the Home Menu	53
Manual speaker setup	53
Speaker Setting	53

X.Over	54
Channel Level	54
Speaker Distance	55
The Input Assign menu	55
Analog Input	55
Component Input (VSX-1029 only)	55
The Auto Power Down menu	56
The Network Standby menu	56
The MHL Setup menu.	56
Auto Switching	56
Setup ROKU standby mode.	56
The Speaker System setting (VSX-1029 only)	57
The OSD Setup menu.	57
08 Using the MULTI-ZONE feature (VSX-1029 only)	
MULTI-ZONE listening	58
Making MULTI-ZONE connections	58
Using the MULTI-ZONE controls	58
09 Control with HDMI function	
Making Control with HDMI connections.	59
HDMI Setup	59
Before using synchronization.	60
About synchronized operations	60
Cautions on the Control with HDMI function	60
10 Additional information	
Troubleshooting	61
General	61
NETWORK feature.	62
Troubleshooting of wireless LAN.	63
HDMI	64
Important information regarding the HDMI connection	64
Windows 8	64
MHL	65
HTC Connect	65
About iPod/iPhone	65
Apple Lossless Audio Codec	65
About FLAC	65
About messages displayed when using network functions	66
Resetting the main unit	66
Cleaning the unit	66
Specifications.	68

Features

Audio

Easy setup using MCACC

The MCACC automatically creates the optimum acoustic environment by compensating for differences in speaker size, level and distance, and equalizing response.

Phase Control

Phase Control effectively eliminates phase lag which makes the sound lack synchronization and significantly improves the multi-channel sound without any extra operation.

Video

Ultra HD (with 4K/60p video support) - Pass-through -

Up to 4K/60p resolution images can be passed through and displayed as such. A separate monitor supporting Ultra HD (4K video) is required.

HDMI (3D, Audio Return Channel)

6 in/1 out

A compatible component is required to use the above function.

Connectivity

Easy Network connection with the Wireless LAN converter

With the AS-WL300 wireless LAN converter, you can enjoy using a wireless LAN connection for the AV receivers. The AS-WL300 works with power supply from the AV receiver's dedicated USB terminal, so no AC adapter is required.

Bluetooth adapter ready

Using the *Bluetooth* ADAPTER (AS-BT100 or AS-BT200) lets you enjoy music files on an iPhone or other *Bluetooth* wireless technology enabled device wirelessly.

MHL™ (Mobile High-definition Link) - compatible device playback

An incorporates MHL 2 mobile device can be connected to enjoy 3D videos, Full-HD videos, high quality multi-channel audio, and photos etc., with charge the battery on the receiver.

iPod Playback

Your iPod or iPhone can be connected to the receiver's USB terminal to play the music files on the iPod or iPhone. Also, the iPod or iPhone is charged when it is connected to the receiver.

Network

Roku Ready®

This receiver is certified Roku Ready®. By just plug the Roku Streaming Stick™ into the MHL port, you can enjoy the hottest movies, TV shows, music, games and more on your TV by streaming it directly from the Internet.

Spotify Digital Music-Streaming Service ready

Spotify is a digital music-streaming service that gives you on-demand access to millions of songs. This receiver is ready for the Connect from Spotify, which lets you select songs on your Spotify app for listening on your audio system. For service availability in your country check www.spotify.com.

Compatible with Windows 8.1

This receiver is compatible with Windows 8.1, letting you easily stream music from compatible PCs on your home network.

Apple AirPlay

With AirPlay you can stream music from iTunes to this receiver and play it through your home theater system. You can even use the receiver to view metadata including song titles, artist as well as the album art on a connected display. You can easily enjoy your iTunes music in any room in the house.

DLNA Certified (1.5)

This receiver is DLNA certified (1.5), enabled to work not only as a DMP (Digital Media Player) for playing DMS (Digital Media Server) audio files, but also as a DMR (Digital Media Renderer) to be remote controlled by a device such as a smartphone or PC.

Internet Radio

By connecting this receiver to the network via the LAN terminal, you can listen to internet radio stations.



Playback / Processing

High Resolution Music Playback

High resolution music files with resolutions of 96 kHz/24 bit to 192 kHz/24 bit can be played. Playback of AIFF, Apple Lossless, WAV and FLAC files via the front USB port and network is supported.

Gapless Playback

The silent section between tracks is skipped when playing music files, eliminating the interruptions that usually occur when playing live or concert contents.

Dolby Pro Logic IIz compatible

Adding a pair of speakers above the front left and right speakers adds expressiveness in the vertical direction to the previous horizontally-oriented sound field. The height channel strengthens the sound field's sense of three-dimensionality and air, producing presence and expansion.

Advanced Sound Retriever

Advanced Sound Retriever restores the output of compressed audio - such as WMA, AAC and MP3 - to the level of CD sound by creating new signals to restore the minor details left out during the compression process.

Installation

iControlAV5 Remote Application

This is an application that allowing intuitive operation of many of the receiver's functions. This application is available on the App Store for iPhone, iPod touch and iPad. And also, you can get it on Google Play for Android smartphones. The application can be downloaded free of charge.

ZONE Ready

This receiver is equipped with the Multi-zone (ZONE2) function. Multi-Zone enables music playback from different sources in two zones at the same time.

Energy Saving Design

This AV receiver has an ecological design. In addition to even lower power consumption in standby, the receiver is equipped with an "eco mode" for low power consumption when playing contents as well. Furthermore, the eco mode can easily be set with a dedicated button on the remote control or the iControlAV5.



Before you start

Checking what's in the box

Please check that you've received the following supplied accessories:

- Setup microphone
- Remote control
- AAA size IEC R03 dry cell batteries (to confirm system operation) x2
- AM loop antenna
- FM wire antenna
- Warranty card
- Quick start guide
- Safety Brochure
- SPEAKER CAUTION Sheet (English only)
- These operating instructions (CD-ROM)

Installing the receiver

- When installing this unit, make sure to put it on a level and stable surface.

Don't install it on the following places:

- on a color TV (the screen may distort)
- near a cassette deck (or close to a device that gives off a magnetic field). This may interfere with the sound.
- in direct sunlight
- in damp or wet areas
- in extremely hot or cold areas
- in places where there is vibration or other movement
- in places that are very dusty
- in places that have hot fumes or oils (such as a kitchen)

Flow of settings on the receiver

The unit is a full-fledged AV receiver equipped with an abundance of functions and terminals. It can be used easily after following the procedure below to make the connections and settings.

The colors of the steps indicate the following:

Required setting item

Setting to be made as necessary

1 Connecting the speakers

Where you place the speakers will have a big effect on the sound.

- Determining the speakers' application ([page 14](#))
- Connecting the speakers ([page 15](#))
- Switching the speaker terminal ([page 18](#))



2 Connecting the components

For surround sound, you'll want to hook up using a digital connection from the Blu-ray Disc/DVD player to the receiver.

- About video outputs connection ([page 19](#))
- Connecting a TV and playback components ([page 20](#))
- Connecting antennas ([page 23](#))
- Plugging in the receiver ([page 25](#))



3 Power On

Make sure you've set the video input on your TV to this receiver. Check the manual that came with the TV if you don't know how to do this.



4 The Speaker System setting (VSX-1029 only) ([page 57](#))

(Specify either using the surround back front height Speaker Bi-amp ZONE 2 speaker.)

The Input Assign menu ([page 55](#))

(When using connections other than the recommended connections.)

HDMI Setup ([page 59](#))

(When the connected TV supports the HDMI Audio Return Channel function.)



5 Use the on-screen automatic MCACC setup to set up your system

- Automatically setting up for surround sound (MCACC) ([page 26](#))



6 Basic playback ([page 28](#))

- Selecting the audio input signal ([page 28](#))
- Playing an iPod ([page 30](#))
- Switches between the iPod controls and the receiver controls ([page 31](#))
- Choosing the listening mode ([page 37](#))



7 Adjusting the sound as desired

- Using the Sound Retriever ([page 38](#))
- Listening with Acoustic Calibration EQ ([page 38](#))
- Using surround back channel processing (VSX-1029 only) ([page 38](#))
- Setting the Up Mix function (VSX-1029 only) ([page 39](#))
- Setting the Audio options ([page 39](#))
- Manual speaker setup ([page 53](#))

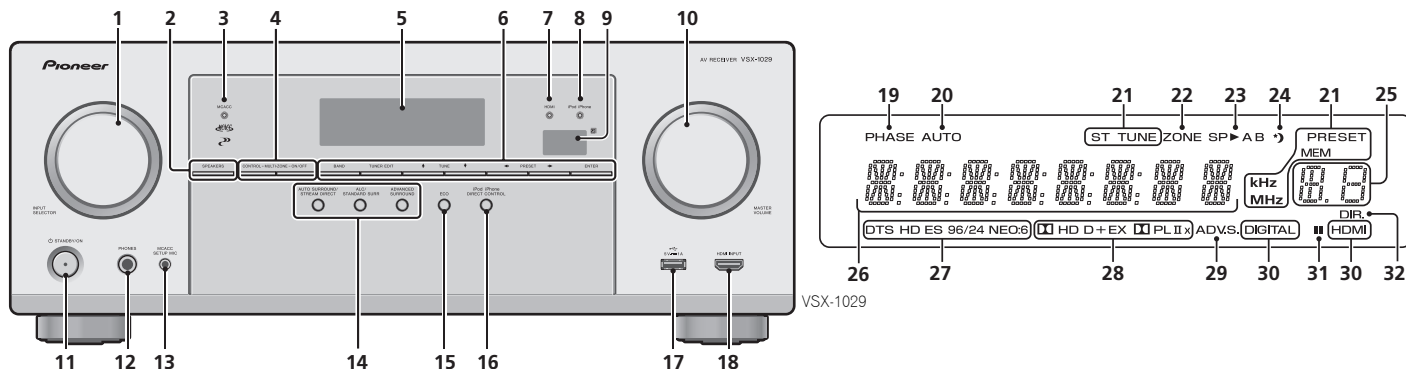

Front panel

**1 INPUT SELECTOR dial**

Selects an input source ([page 28](#)).

2 SPEAKERS

See [Switching the speaker terminal on page 18](#).

The Speaker System setting may or may not be displayed, depending on the input source you have selected.

3 MCACC indicator

Lights when Acoustic Calibration EQ ([page 38](#)) is on (Acoustic Calibration EQ is automatically set to on after the Auto MCACC setup ([page 26](#))).

4 ZONE controls (VSX-1029 only)

If you've made MULTI-ZONE connections (see [Making MULTI-ZONE connections on page 58](#)) use these controls to control the sub zone from the main zone (see [Using the MULTI-ZONE controls on page 58](#)).

Receiver control buttons (VSX-824 only)

DIMMER – Dims or brightens the display. The brightness can be controlled in four steps.

STATUS – Switches the display of this unit. The listening mode, input format, sound volume, input name can be checked by selecting an input source.

The Input format may or may not be displayed, depending on the input source you have selected.

5 Character display

See [Display on page 10](#).

6 Tuner control buttons

BAND – Switches between AM, FM ST (stereo) and FM MONO radio bands ([page 36](#)).

TUNER EDIT – Use with **TUNE** \uparrow/\downarrow . **PRESET** \leftarrow/\rightarrow and **ENTER** to memorize and name stations for recall ([page 36](#)).

TUNE \uparrow/\downarrow – Used to find radio frequencies ([page 36](#)).

PRESET \leftarrow/\rightarrow – Use to select preset radio stations ([page 36](#)).

7 HDMI indicator

Blinks when connecting an HDMI-equipped component; lights when the component is connected ([page 20](#)).

8 iPod/iPhone indicator

Lights when an iPod/iPhone is connected and iPod/iPhone input is selected ([page 30](#)).

9 Remote sensor

Receives the signals from the remote control (see [Operating range of remote control on page 13](#)).

10 MASTER VOLUME dial**11 STANDBY/ON****12 PHONES jack**

Use to connect headphones. When the headphones are connected, there is no sound output from the speakers. The listening mode when the sound is heard from the headphone can be selected only from **PHONES SURR**, **STEREO** or **STEREO ALC** mode (**S.R AIR** mode can be also selected with **ADAPTER** input).

13 MCACC SETUP MIC jack

Use to connect a microphone when performing Auto MCACC setup ([page 26](#)).

14 Listening mode buttons

AUTO SURROUND/STREAM DIRECT – Switches between Auto surround mode ([page 37](#)) and Stream Direct playback ([page 38](#)).

ALC/STANDARD SURR (VSX-1029 only) – Press for standard decoding and to switch between the modes of

Pro Logic II, Pro Logic IIx, Pro Logic IIz and NEO:6, and the Auto level control stereo mode (page 37).

ALC/STANDARD SURR (VSX-824 only) – Press for standard decoding and to switch between the modes of

Pro Logic II and NEO:6, and the Auto level control stereo mode (page 37).

ADVANCED SURROUND – Switches between the various surround modes (page 38).

15 ECO

Switches between ECO Mode 1/ECO Mode 2. When ECO Mode is turned **ON**, the display will go dark (page 38).

16 iPod iPhone DIRECT CONTROL

Change the receiver's input to the **iPod** and enable iPod operations on the iPod (page 32).

17 iPod/iPhone terminals

Use to connect your Apple iPod/iPhone or USB mass storage device as an audio source (page 24).

18 HDMI INPUT connector

Use for connection to a compatible HDMI device (Video camera, etc.) (page 25).

Display

19 PHASE

Lights when the Phase Control is switched on.

20 AUTO

Lights when the Auto Surround feature is switched on (page 37).

21 Tuner indicators

ST – Lights when a stereo FM broadcast is being received in auto stereo mode (page 36).

TUNE – Lights when a normal broadcast channel.

PRESET – Shows when a preset radio station is registered or called.

MEM – Blinks when a radio station is registered.

kHz/MHz – Lights when the character display is showing the currently received AM/FM broadcast frequency.

22 ZONE (VSX-1029 only)

Lights when the MULTI-ZONE feature is active (page 58).

23 Speaker indicators

Shows if the speaker system is on or not (page 18).

24 Sleep timer indicator

Lights when the receiver is in sleep mode (page 11).

25 PRESET information or input signal indicator

Shows the preset number of the tuner or the input signal type, etc.

26 Character display

Displays various system information.

27 DTS indicators

DTS – Lights when a source with DTS encoded audio signals is detected.

HD – Lights when a source with DTS-EXPRESS or DTS-HD encoded audio signals is detected.

ES – Lights to indicate DTS-ES decoding.

96/24 – Lights when a source with DTS 96/24 encoded audio signals is detected.

NEO:6 – When one of the NEO:6 modes of the receiver is on, this lights to indicate NEO:6 processing (page 37).

28 Dolby Digital indicators

D – Lights when a Dolby Digital encoded signal is detected.

D+ – Lights when a source with Dolby Digital Plus encoded audio signals is detected.

HD – Lights when a source with Dolby TrueHD encoded audio signals is detected.

EX (VSX-1029 only) – Lights to indicate Dolby Digital EX decoding.

PLII(x) (VSX-1029 only) – Lights to indicate Pro Logic II decoding. Light will go off during Pro Logic IIz decoding (see [Listening in surround sound on page 37](#) for more on this).

PLII (VSX-824 only) – Lights to indicate Pro Logic II decoding. (see [Listening in surround sound on page 37](#) for more on this).

29 ADV.S.

Lights when one of the Advanced Surround modes has been selected (see [Using the Advanced surround on page 38](#) for more on this).

30 SIGNAL SELECT indicators

DIGITAL – Lights when a digital audio signal is selected. Blinks when a digital audio signal is selected and selected audio input is not provided.

HDMI – Lights when an HDMI signal is selected. Blinks when an HDMI signal is selected and selected HDMI input is not provided.

31 Up Mix indicator (VSX-1029 only)

Lights when the Up Mix function is set to **ON** (page 39).

32 DIR.

Lights when the **DIRECT** or **PURE DIRECT** mode is switched on (page 38).



Remote control

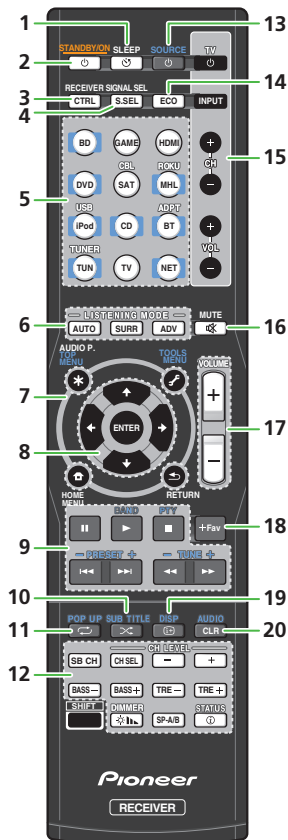

• The following buttons are not used with this receiver:

– **PTY**, **SHIFT**

1 SLEEP

Press to change the amount of time before the receiver switches into standby (**30 min – 60 min – 90 min – Off**). You can check the remaining sleep time at any time by pressing **SLEEP** once.

2 STANDBY/ON

Switches the receiver between standby and on.

3 RECEIVER CTRL

Switches the remote to control the receiver. Also use this button to set up **HOME MENU** (page 53) or Audio parameters (page 39).

4 SIGNAL SEL S.SEL

Press to select the audio input signal of the component to play back (page 28).

5 Input function buttons

Use to select the input source to this receiver (page 28). Also switch the remote control mode when operating other device and various inputs (**TUNER**, etc.).

6 Listening mode buttons

AUTO – Switches between Auto surround mode (page 37) and Stream Direct playback (page 38).

SURR (VSX-1029 only) – Press for standard decoding and to switch between the modes of **IX** Pro Logic II, **IX** Pro Logic IIx, **IX** Pro Logic IIz and NEO:6, and the Auto level control stereo mode (page 37).

SURR (VSX-824 only) – Press for standard decoding and to switch between the modes of **IX** Pro Logic II and NEO:6, and the Auto level control stereo mode (page 37).

ADV – Switches between the various surround modes (page 38).

7 Receiver and component control buttons

The following button controls can be accessed after you have selected the corresponding input function button (**BD**, **DVD**, etc.).

Press **RECEIVER** first to access:

AUDIO P. – Use to access the Audio options (page 39).

HOME MENU – Press to access the Home Menu (page 53).

RETURN – Confirm and exit the current menu screen. Press **BD** and **DVD** first to access:

TOP MENU – Displays the disc 'top' menu of a Blu-ray Disc/DVD.

HOME MENU – Displays the HOME MENU screen.

RETURN – Confirm and exit the current menu screen.

MENU – Displays the TOOLS menu of Blu-ray Disc player.

Press **TUNER** first to access:

TOOLS – Memorizes stations for recall (page 36), also used to change the name (page 36).

BAND – Switches between AM, FM ST (stereo) and FM MONO radio bands (page 36).

Press **iPod USB** first to access:

HOME MENU – Switches between the iPod controls and the receiver controls (page 31).

8 ↑/↓/←/→, ENTER

Use the arrow buttons when setting up your surround sound system (page 53). Also used to control Blu-ray Disc/DVD menus/options.

9 Component control buttons

The main buttons (▶, ■, etc.) are used to control a component after you have selected it using the input function buttons.

The **BD**, **DVD**, and **CD** operation using the component control buttons are limited only to Pioneer components.

The controls above these buttons can be accessed after you have selected the corresponding input function button (**BD**, **DVD** and **CD**). These buttons also function as described below.

Press **TUNER** first to access:

Use **TUNE +/-** can be used to find radio frequencies and **PRESET +/-** can be used to select preset radio stations (page 36).

10 SUB TITLE

The subtitle will be switched for **BD** and **DVD**.

CD, NETWORK, iPod/USB, MHL, and BT (ADPT) will be random playback.

11 POP UP ↻

Popup menu will be displayed for **BD**.

CD, NETWORK, iPod/USB, MHL, and BT (ADPT) will be repeat playback.

12 Other component controls

There are other buttons that can be accessed after **RECEIVER** is pressed.

SB CH (VSX-1029 only) – Press to select **ON, AUTO** or **OFF** the surround back channel (page 38).

CH SEL – Press repeatedly to select a channel, then use **CH LEVEL +/-** to adjust the level (page 54).

CH LEVEL +/- – Use to adjust the channel level.

BASS +/-, TRE +/- – Use to adjust Bass or Treble.

- These controls are disabled when the listening mode is set to **DIRECT** or **PURE DIRECT**.
- When the front speaker is set at **SMALL** in the Speaker Setting (or automatically via the Auto MCACC setup) and the X.Over is set above 150 Hz, the subwoofer channel level will be adjusted by pressing **BASS +/-** (page 54).

DIMMER ☀/☿ – Dims or brightens the display. The brightness can be controlled in four steps.

During ECO mode, the brightness switches between 2 levels. If the dimmest level is selected, DIMMER will be shown on the display. (Mode other than ECO: 4 levels, ECO mode: 2 levels)

SP-A/B – See *Switching the speaker terminal on page 18*.

STATUS ⓘ – Switches the display of this unit. The listening mode, input format, sound volume, Speaker System (VSX-1029) setting or input name can be checked by selecting an input source.

The Input format may or may not be displayed, depending on the input source you have selected.

The Speaker System setting may or may not be displayed, depending on the input source you have selected.

13 ⏻SOURCE

Press to turn on/off the power to the Pioneer device connected to the receiver.

14 ECO

Switches between ECO Mode 1/ECO Mode 2. When ECO Mode is turned **ON**, the display will go dark (page 38).

15 TV buttons

Operates a TV. When operating other manufacturer's TV, setup as follows.

⏻ – Use to turn on/off the power of the TV.

INPUT – Use to select the TV input signal.

CH +/- – Use to select channels.

VOL +/- – Use to adjust the volume on your TV.

While holding down **TV ⏻** button, press the input function buttons (listed in the table below) for component you want to control for about five seconds.

This may not operate depending on the TV.

Default setting: Pioneer

TV preset

Input Function button	TV Brand
RECEIVER CTRL	Pioneer
BD	Panasonic
GAME	Sony
HDMI	Sharp
DVD	Toshiba
SAT	Mitsubishi
MHL	Philips/AOC/TPV
iPod	Vizio
CD	Samsung
BT/ADPT	LG Electric
TUNER	Skyworth
TV	Hisense
NET	TCL

16 MUTE 🔇

Mutes/unmutes the sound.

17 VOLUME +/-

Use to set the listening volume.

18 +Fav

Press while a song is being played back or stopped. The selected song is then registered in the Favorites folder (page 45).

19 DISP ⓘ

Each entry source information will be displayed.

20 AUDIO CLR

Songs and preset radio stations registered will be deleted when **NETWORK** is selected.

Audio will be switched when set to other than **NETWORK**.

Loading the batteries

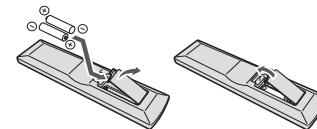

The batteries included with the unit are to check initial operations; they may not last over a long period. We recommend using alkaline batteries that have a longer life.

⚠ WARNING

- Do not use or store batteries in direct sunlight or other excessively hot place, such as inside a car or near a heater. This can cause batteries to leak, overheat, explode or catch fire. It can also reduce the life or performance of batteries.

⚠ CAUTION

- Incorrect use of batteries may result in such hazards as leakage and bursting. Observe the following precautions:
 - Never use new and old batteries together.
 - Insert the plus and minus sides of the batteries properly according to the marks in the battery case.
 - Batteries with the same shape may have different voltages. Do not use different batteries together.
 - When disposing of used batteries, please comply with governmental regulations or environmental public institution's rules that apply in your country/area.
 - When inserting the batteries, make sure not to damage the springs on the battery's (-) terminals. This can cause batteries to leak or overheat.

Operating range of remote control

The remote control may not work properly if:

- There are obstacles between the remote control and the receiver's remote sensor.
- Direct sunlight or fluorescent light is shining onto the remote sensor.
- The receiver is located near a device that is emitting infrared rays.
- The receiver is operated simultaneously with another infrared remote control unit.

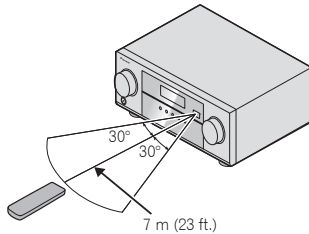

Determining the speakers' application

The unit permits you to build various surround systems, in accordance with the number of speakers you have.

If you have two subwoofers, the second subwoofer can be connected to the **SUBWOOFER 2** terminal. Connecting two subwoofers increases the bass sound to achieve more powerful sound reproduction.

In this case, the same sound is output from the two subwoofers.

The 5.1 channel surround system is the most commonly-used in home theaters. To achieve the best possible surround sound, install your speakers as shown below.

5.1 channel surround system:

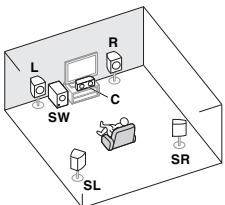

7.1 channel surround system (Surround back) system (VSX-1029 only):

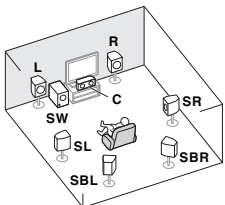

6.1 channel surround (Surround back) system (VSX-1029 only):

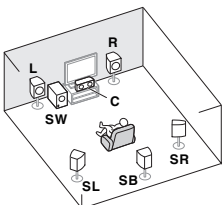

7.1 channel surround (Front height) system (VSX-1029 only):

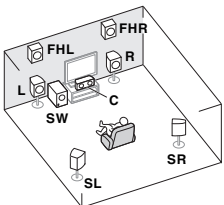

Important

VSX-1029 only

- Both the surround back speakers and the front height speakers can be connected at the same time. In this case, sound will be output from either the front height speaker or the surround back speaker depending on which one was selected in the **Speaker System** setting (see [The Speaker System setting \(VSX-1029 only\) on page 57](#)).

Speaker B connection

You can use the speakers connected to the B speaker terminals to listen to stereo playback in another room. See [Switching the speaker terminal on page 18](#) for the listening options with this setup.

- You will not be able to connect the B speakers if you connect the front height speakers in the main zone.**

Further, if you use the B speakers, a 5.1 ch playback will be the maximum in the main zone. (No sound is output from the surround back speaker.)

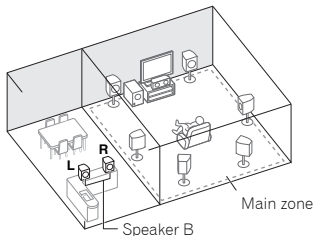

Bi-amping connection

Bi-amping connection of the front speakers for high sound quality with 5.1-channel surround sound.

- When using the Front Bi-amping connection, sound will only be output from the front speakers, the surround speakers and the subwoofer.

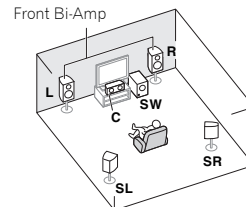

ZONE 2 connection (Multi Zone)

With these connections you can simultaneously enjoy the surround sound in the main zone with stereo playback on another component in ZONE 2 (The selection of input devices is limited). See [MULTI-ZONE listening on page 58](#).

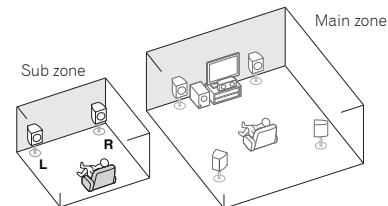

Some tips for improving sound quality

Where you put your speakers in the room has a big effect on the quality of the sound. The following guidelines should help you to get the best sound from your system.

- It is best to angle the speakers towards the listening position. The angle depends on the size of the room. Use less of an angle for bigger rooms.
- Refer to the chart below for placement of speakers you intend to connect.

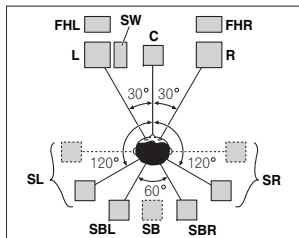

- Place the surround speakers at 120° from the center. If you, (1) use the surround back speaker, and, (2) don't use the front height speakers, we recommend placing the surround speaker right beside you.
- If you intend to connect only one surround back speakers, place it directly behind you.
- If the surround speakers cannot be set directly to the side of the listening position with a 7.1-channel system, the surround effect can be enhanced by turning off the Up Mix function (see [Setting the Up Mix function \(VSX-1029 only\)](#) on page 39).
- For the best stereo effect, place the front speakers 2 m to 3 m apart, at equal distance from the TV.
- If you're using a center speaker, place the front speakers at a wider angle. If not, place them at a narrower angle.
- Place the center speaker above or below the TV so that the sound of the center channel is localized at the TV screen. Also, make sure the center speaker does not cross the line formed by the leading edge of the front left and right speakers.
- Surround and surround back speakers should be positioned 60 cm to 90 cm higher than your ears and tilted slight downward. Make sure the speakers don't face each other. For DVD-Audio, the speakers should be more directly behind the listener than for home theater playback.
- Try not to place the surround speakers farther away from the listening position than the front and center speakers. Doing so can weaken the surround sound effect.
- Place the left and right front height speakers at least one meter directly above the left and right front speakers.
- If you're going to place speakers around your CRT TV, use shielded speakers or place the speakers at a sufficient distance from your CRT TV.
- The subwoofer can be placed on the floor. Ideally, the other speakers should be at about ear-level when you're listening to them. Putting the speakers on the floor (except the subwoofer), or mounting them very high on a wall is not recommended.
- When not connecting a subwoofer, connect speakers with low frequency reproduction capabilities to the front channel. (The subwoofer's low frequency component is played from the front speakers, so the speakers could be damaged.)
- **After connecting, be sure to conduct the Auto MCACC (speaker environment setting) procedure.**
See [Automatically setting up for surround sound \(MCACC\)](#) on page 26.

CAUTION

- Make sure that all speakers are securely installed. This not only improves sound quality, but also reduces the risk of damage or injury resulting from speakers being knocked over or falling in the event of external shocks such as earthquakes.

Connecting the speakers

The receiver will work with just two stereo speakers (the front speakers in the diagram) but using at least three speakers is recommended, and a complete setup is best for surround sound.

Make sure you connect the speaker on the right to the right (R) terminal and the speaker on the left to the left (L) terminal. Also make sure the positive and negative (+/-) terminals on the receiver match those on the speakers.

You can use speakers with a normal impedance between 6 Ω and 16 Ω.

Be sure to complete all connections before connecting this unit to the AC power source.

Bare wire connections

- 1 Twist exposed wire strands together.
- 2 Loosen terminal and insert exposed wire.
- 3 Tighten terminal.

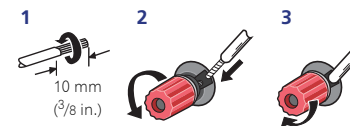

Connect the wires to the B-Speakers terminals of the VSX-1029 as shown below:

- 1 Twist exposed wire strands together.
- 2 Push open the tabs and insert exposed wire.
- 3 Release the tabs.

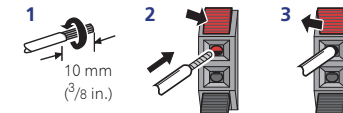

CAUTION

- These speaker terminals carry **HAZARDOUS LIVE voltage**. To prevent the risk of electric shock when connecting or disconnecting the speaker cables, disconnect the power cord before touching any uninsulated parts.
- Make sure that all the bare speaker wire is twisted together and inserted fully into the speaker terminal. If any of the bare speaker wire touches the back panel it may cause the power to cut off as a safety measure.

Connect the surround back or front height speakers (VSX-1029 only)

The Speaker System setting must be set if the above connections are performed. Select **Surr.Back** if the surround back speaker is connected and **Height** if the front height speaker is connected (If neither the surround back speaker nor the front height speaker is connected, either setting will suffice) (see [The Speaker System setting \(VSX-1029 only\) on page 57](#)).

- When using only one surround back speaker, connect it to the **SURROUND BACK L (Single)** terminals.

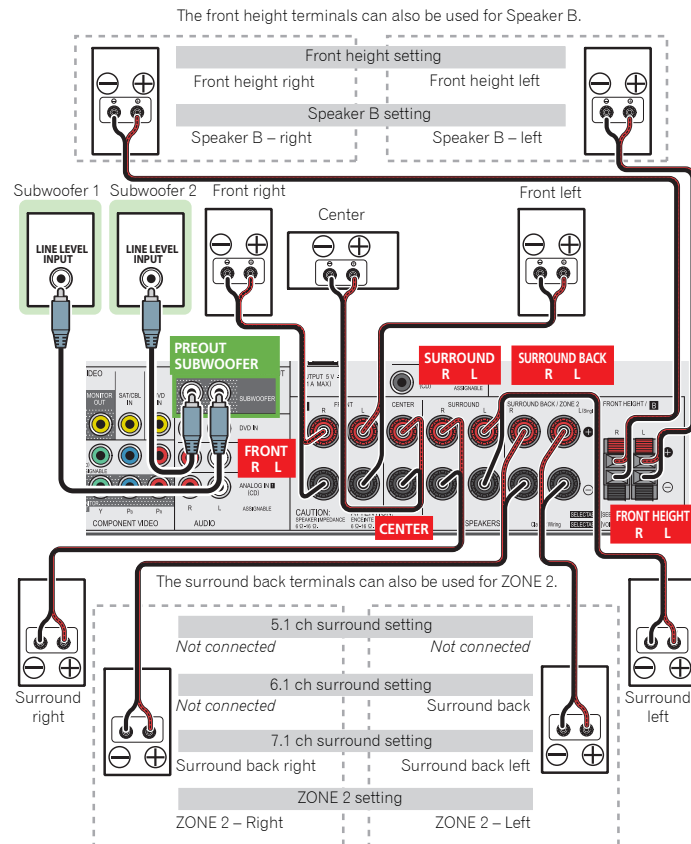
VSX-1029 connection diagram

Front Bi-Amp connection (VSX-1029 only)

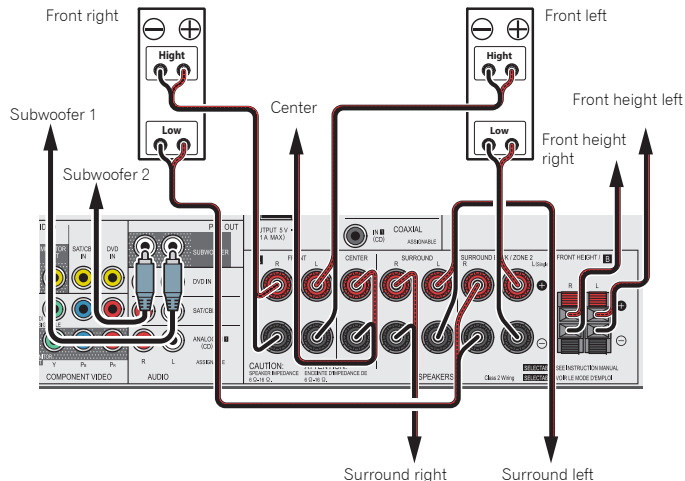

VSX-824 connection diagram

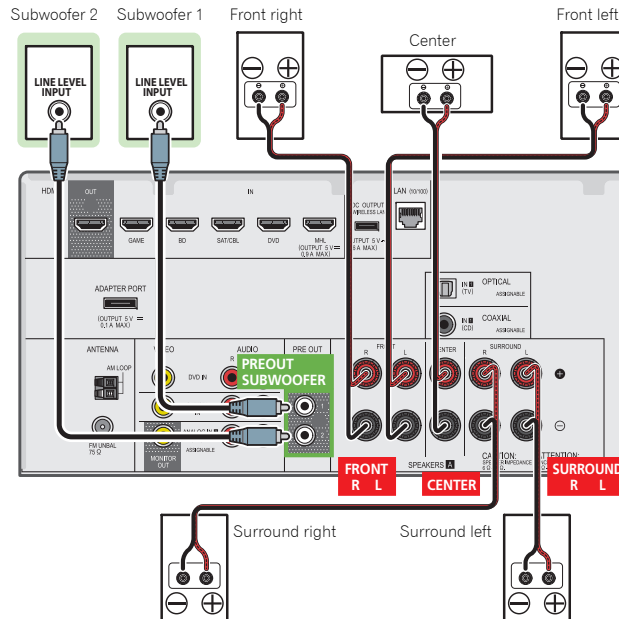

Switching the speaker terminal

VSX-1029: When the [The Speaker System setting \(VSX-1029 only\) on page 57](#) is set to **SP▶B**, each press of the speaker button will switch the speaker used for playback: **SP▶**, **SP▶A**, **SP▶B**, **SP▶AB**.

VSX-824: Each press of the speaker button will switch the speaker used for playback: **SP▶**, **SP▶A**.

When the speaker system is set to SP-B: Each press of the speaker button will switch the speaker used for playback: OFF, A, B, AB.

When the speaker system is set to anything other than SP-B: Each press of the speaker button will switch the speaker used for playback: OFF, A. For more details on the speaker system please refer to [The Speaker System setting \(VSX-1029 only\) on page 57](#).

Press repeatedly to choose a speaker terminal option:

- **SP▶A** – Sound is output from the speakers connected to the A-speaker terminals (multichannel playback is possible).
- **SP▶B** (VSX-1029 only) – Sound is output from the two speakers connected to the B-speaker terminals (only stereo playback is possible).
- **SP▶AB** (VSX-1029 only) – Sound is output from the A-speaker terminals, the two speakers in the B-speaker terminals, and the subwoofer. Multichannel sources are downmixed only when the **STEREO** or **STEREO ALC** mode is selected for stereo output from A- and B-speaker terminals.
- **SP▶** – No sound is output from the speakers.

Note

- **VSX-1029 only:** The subwoofer output depends on the settings you made in [Speaker Setting on page 53](#). However, if **SP▶B** is selected above, no sound is heard from the subwoofer (the LFE channel is not downmixed).
- All speaker terminals are switched off (**SP▶**) when headphones are connected. **SP▶B** can be selected even when headphones are connected for VSX-1029.

Making cable connections

Make sure not to bend the cables over the top of this unit (as shown in the illustration). If this happens, the magnetic field produced by the transformers in this unit may cause a humming noise from the speakers.

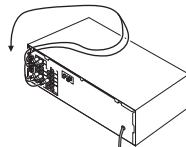

Important

- Before making or changing connections, switch off the power and disconnect the power cord from the AC outlet.
- Before unplugging the power cord, switch the power into standby.

HDMI cables

Both video and sound signals can be transmitted simultaneously with one cable. If connecting the player and the TV via this receiver, for both connections, use HDMI cables.

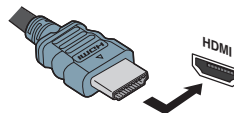

Be careful to connect the terminal in the proper direction.

Note

- Set the HDMI parameter in [Setting the Audio options on page 39](#) to **THRU** (THROUGH) and set the input signal in [Selecting the audio input signal on page 28](#) to **HDMI**, if you want to hear HDMI audio output from your TV (no sound will be heard from this receiver).
- If the video signal does not appear on your TV, try adjusting the resolution settings on your component or display. Note that some components (such as video game units) have resolutions that may not be displayed. In this case, use a (analog) composite connection.
- When the video signal from the HDMI is 480i, 480p, 576i or 576p, Multi Ch PCM sound and HD sound cannot be received.

About HDMI

The HDMI connection transfers uncompressed digital video, as well as almost every kind of digital audio that the connected component is compatible with, including DVD-Video, DVD-Audio, SACD, Dolby Digital Plus, Dolby TrueHD, DTS-HD Master Audio (see below for limitations), Video CD/ Super VCD and CD.

This receiver incorporates High-Definition Multimedia Interface (HDMI[®]) technology. This receiver supports the functions described below through HDMI connections.

- Digital transfer of uncompressed video (contents protected by HDCP (1080p/24, 1080p/60, etc.))
- 3D signal transfer
- Deep Color signal transfer
- x.v.Color signal transfer
- Audio Return Channel
- Input of multi-channel linear PCM digital audio signals (192 kHz or less) for up to 8 channels
- Input of the following digital audio formats:
 - Dolby Digital, Dolby Digital Plus, DTS, High bitrate audio (Dolby TrueHD, DTS-HD Master Audio), DVD-Audio, CD, SACD (DSD 2 ch only), Video CD, Super VCD
- Synchronized operation with components using the **Control** with HDMI function (see [Control with HDMI function on page 59](#))
- 4K signal transfer
 - This may not operate properly, depending on the connected equipment.
 - 4K 24p, 4K 25p, 4K 30p, 4K 50p and 4K 60p signals are supported

Note

- Use a High Speed HDMI[®]/™ Cable. If HDMI cable other than a High Speed HDMI[®]/™ Cable is used, it may not work properly.
- When an HDMI cable with a built-in equalizer is connected, it may not operate properly.
- 3D, Deep Color, x.v.Color, 4K signal transfer and Audio Return Channel are only possible when connected to a compatible component.
- HDMI format digital audio transmissions require a longer time to be recognized. Due to this, interruption in the audio may occur when switching between audio formats or beginning playback.

- Turning on/off the device connected to this unit's HDMI OUT terminal during playback, or disconnecting/connecting the HDMI cable during playback, may cause noise or interrupted audio.



The terms *HDMI* and *HDMI High-Definition Multimedia Interface*, and the *HDMI Logo* are trademarks or registered trademarks of *HDMI Licensing, LLC* in the United States and other countries.

"x.v.Color" and **x.v.Color** are trademarks of Sony Corporation.

Analog audio cables

Use stereo RCA phono cables to connect analog audio components. These cables are typically red and white, and you should connect the red plugs to R (right) terminals and white plugs to L (left) terminals.

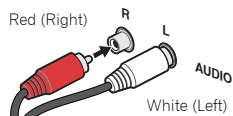

Digital audio cables

Commercially available coaxial digital audio cables or optical cables should be used to connect digital components to this receiver.

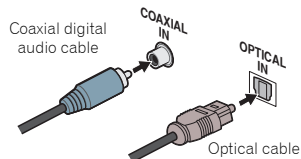

Note

- When connecting optical cables, be careful when inserting the plug not to damage the shutter protecting the optical socket.
- When storing optical cable, coil loosely. The cable may be damaged if bent around sharp corners.
- You can also use a standard RCA video cable for coaxial digital connections.

Video cables

Standard RCA video cables

These cables are the most common type of video connection and are used to connect to the composite video terminals. The yellow plugs distinguish them from cables for audio.



Component video cables (VSX-1029 only)

Use component video cables to get the best possible color reproduction of your video source. The color signal of the TV is divided into the luminance (Y) signal and the color (PB and PR) signals and then output. In this way, interference between the signals is avoided.

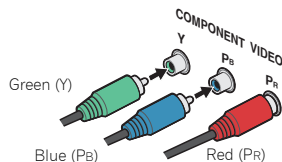

About video outputs connection

This receiver is not loaded with a video converter. When you use HDMI cables for connecting to the input device, the same cables should be used for connecting to the TV.

The signals input from the analog (composite) video inputs of this unit will not be output from the **HDMI OUT** terminal.

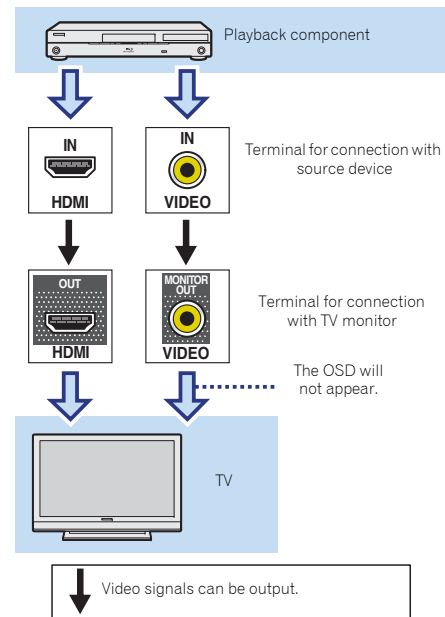

Connecting a TV and playback components

Connecting using HDMI

If you have an HDMI or DVI (with HDCP) equipped component (Blu-ray Disc player, etc.), you can connect it to this receiver using a commercially available HDMI cable.

If the TV and playback components support the **Control** with HDMI feature, the convenient **Control** with HDMI functions can be used (see [Control with HDMI function on page 59](#)).

- The following connection/setting is required to listen to the sound of the TV over this receiver.
 - If the TV does not support the HDMI Audio Return Channel function, connect the receiver and TV with audio cables (as shown).
 - If the TV supports the HDMI Audio Return Channel function, the sound of the TV can be input to the receiver via the HDMI terminal, so there is no need to connect an audio cable. In this case, set **ARC at HDMI Setup to ON** (see [HDMI Setup on page 59](#)).
 - Please refer to the TV's operation manual for directions on connections and setup for the TV.

Note

- In order to listen to the audio from the TV that is connected to this receiver using an analog audio cables, set-up for analog audio input is required (see [The Input Assign menu on page 55](#)).

On 4K support for HDMI input terminal

Supports the following HDMI input terminals:

- (BD, GAME, SAT/CBL)**- 4K/60p, 4K/50p, 4K/30p, 4K/25p, 4K/24p.
- (DVD, MHL)**- 4K/30p, 4K/25p, 4K/24p.

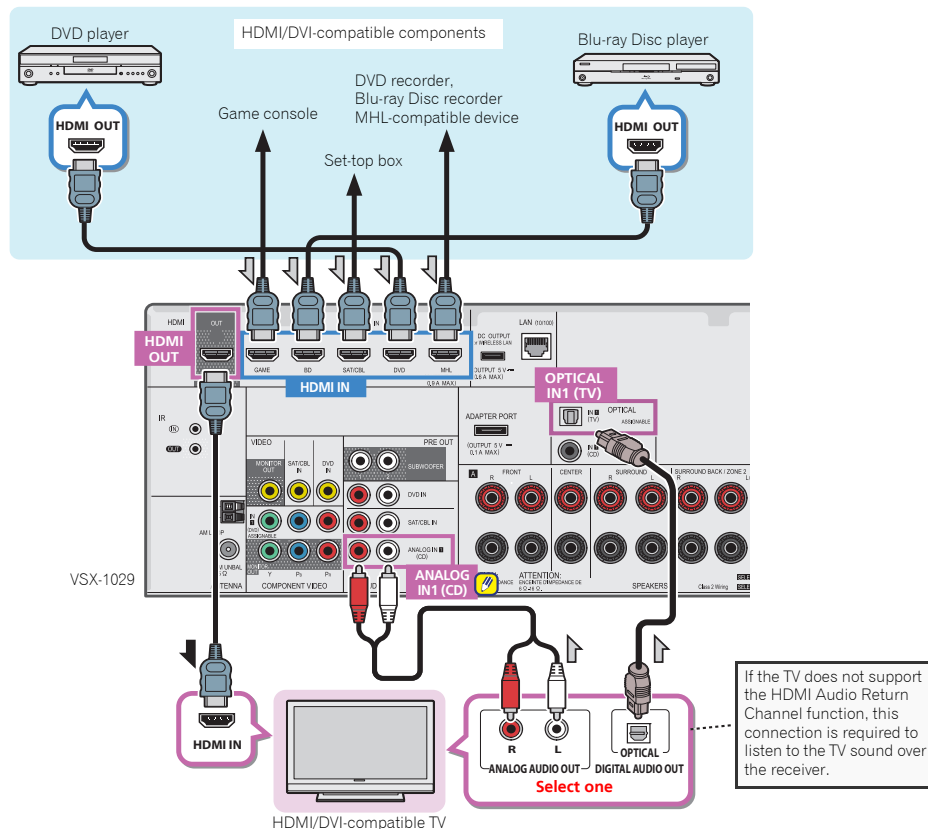

Connecting your TV with no HDMI input

This diagram shows connections of a TV (with no HDMI input) and DVD player (or other playback component) to the receiver.

- With these connections, the picture is not output to the TV even if the DVD player is connected with an HDMI cable.
- In order to listen to HD audio with this receiver, connect an HDMI cable, and use analog video cable for video signal input.

Depending on the player, it may not be possible to output video signals to both HDMI and other video output (composite, etc.) simultaneously, and it may be necessary to make video output settings. Please refer to the operating instructions supplied with your player for more information.

Important

- When the receiver and TV are connected by composite cable, the OSD function allowing display of the receiver's settings, operations, etc., on the TV's screen cannot be used. In this case, watch the receiver's front panel display while performing the various operations and making settings.

Note

- In order to listen to the audio from the TV that is connected to this receiver using analog audio cables, set-up for analog audio input is required (see [The Input Assign menu on page 55](#)).
- Only one component can be connected to both the optical input terminal and coaxial input terminal. If connecting other devices, please use a different method to connect the audio.

In order to listen to the audio from the source component that is connected to this receiver using an optical cable or a coaxial cable, first, switch to the **DVD** (DVD player) or **SAT/CBL** (set-top box), then use **S. SEL** to choose the audio signal **O1** (OPTICAL1) or **C1** (COAXIAL1) (see [Selecting the audio input signal on page 28](#)).

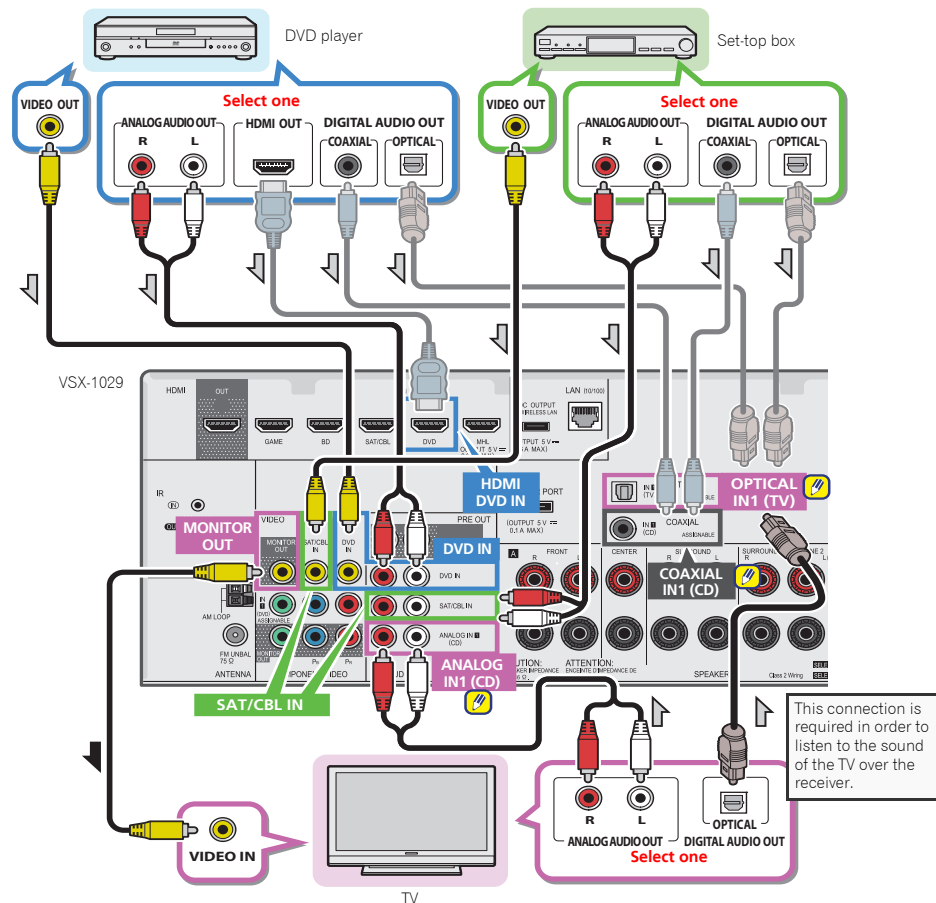

Connecting optional Bluetooth® ADAPTER

When the *Bluetooth* ADAPTER (Pioneer Model No. AS-BT100 or AS-BT200) is connected to this unit, a product equipped with *Bluetooth* wireless technology (portable cell phone, digital music player, etc.) can be used to listen to music wirelessly.

▶ Connect a Bluetooth ADAPTER to the ADAPTER PORT terminal on the rear panel.

- For instructions on playing the *Bluetooth* wireless technology device, see [Pairing the Bluetooth ADAPTER and Bluetooth wireless technology device on page 34](#).

🔔 Important

- Do not move the receiver with the *Bluetooth* ADAPTER connected. Doing so could cause damage or faulty contact.

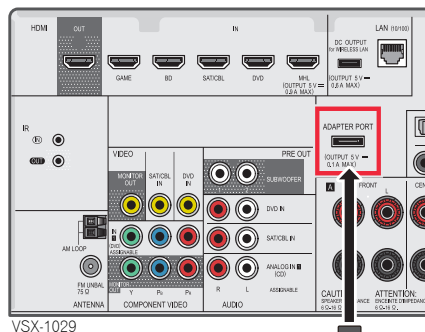

Bluetooth® ADAPTER

Connecting to the network through LAN interface

By connecting this receiver to the network via the LAN terminal, you can listen to Internet radio stations. To listen to Internet radio stations, you must sign a contract with an ISP (Internet Service Provider) beforehand.

When connected in this way, you can play audio files stored on the components on the local network, including your computer.

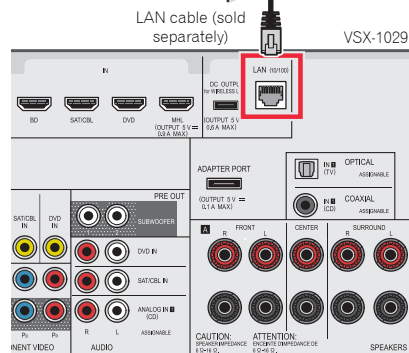
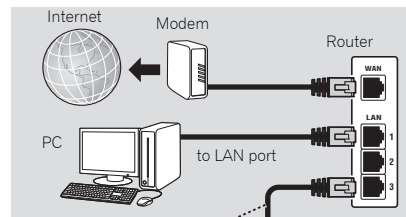

Connect the LAN terminal on this receiver to the LAN terminal on your router (with or without the built-in DHCP server function) with a straight LAN cable (CAT 5 or higher).

Turn on the DHCP server function of your router. In case your router does not have the built-in DHCP server function, it is necessary to set up the network manually. For details, see [The Network Setup menu on page 46](#).

Note

- Refer to the operation manual of the equipment you have as the connected equipment and connection method may differ depending on your Internet environment.
- When using a broadband Internet connection, a contract with an Internet service provider is required. For more details, contact your nearest Internet service provider.

Connecting to a wireless LAN

Wireless connection to the network is possible through a wireless LAN connection. Use the separately sold AS-WL300 for connection.

For details, refer to the operating instructions of the wireless LAN converter.

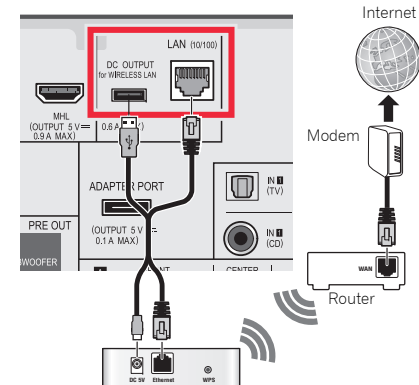

Wireless LAN converter (AS-WL300)

Connecting antennas

Connect the AM loop antenna and the FM wire antenna as shown below. To improve reception and sound quality, connect external antennas (see [Using external antennas below](#)).

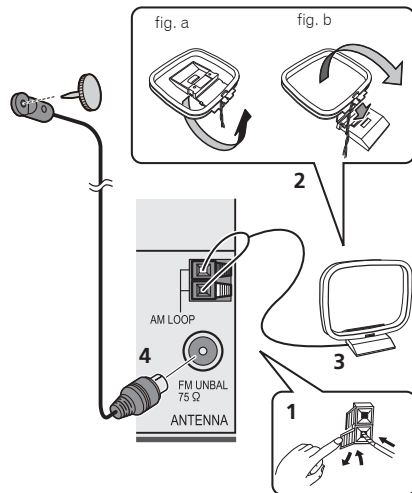

- 1 Push open the tabs, then insert one wire fully into each terminal, then release the tabs to secure the AM antenna wires.**
- 2 Fix the AM loop antenna to the attached stand.**
To fix the stand to the antenna, bend in the direction indicated by the arrow (fig. a) then clip the loop onto the stand (fig. b).

- 3 Place the AM antenna on a flat surface and in a direction giving the best reception.**

- 4 Connect the FM wire antenna into the FM antenna socket.**

For best results, extend the FM antenna fully and fix to a wall or door frame. Don't drape loosely or leave coiled up.

Using external antennas

To improve FM reception

Use an F connector (not supplied) to connect an external FM antenna.

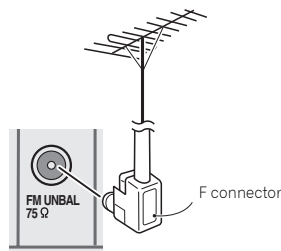

To improve AM reception

Connect a 5 m to 6 m (16 ft. to 20 ft.) length of vinyl-coated wire to the AM antenna terminal without disconnecting the supplied AM loop antenna.

For the best possible reception, suspend horizontally outdoors.

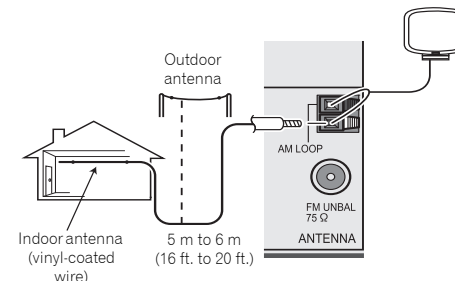

Connecting an IR receiver (VSX-1029 only)

If you keep your stereo components in a closed cabinet or shelving unit, or you wish to use the sub zone remote control in another zone, you can use an optional IR receiver (such as a Niles or Xantech unit) to control your system instead of the remote sensor on the front panel of this receiver.

Note

- Remote operation may not be possible if direct light from a strong fluorescent lamp is shining on the IR receiver remote sensor window.
- Note that other manufacturers may not use the IR terminology. Refer to the manual that came with your component to check for IR compatibility.

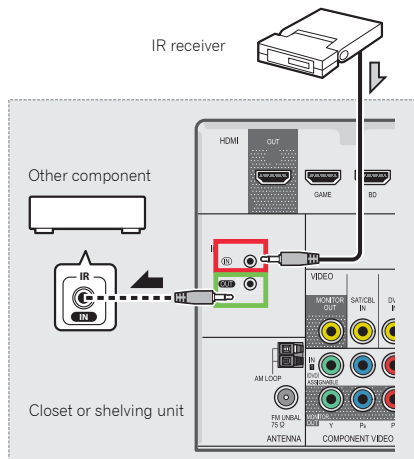

- ▶ **Connect the IR receiver sensor to the IR IN jack on the rear of this receiver.**

For more information on connecting the IR receiver, see the Installation Instructions for the IR Receiver.

Connecting an iPod

This receiver has a dedicated iPod/iPhone terminals that will allow you to control playback of audio content from your iPod using the controls of this receiver.

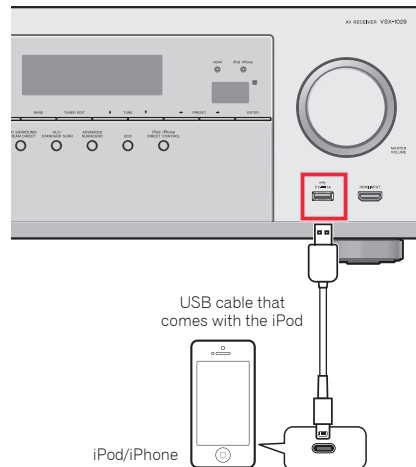

Note

- An iPod/iPhone can be connected to the receiver. For details on supported models and versions of the respective products, see [Playing an iPod on page 30](#).
- ▶ **Switch the receiver into standby, and then use the iPod cable to connect your iPod to the iPod/iPhone terminals on the front panel of this receiver.**
- For the cable connection, also refer to the operating instructions for your iPod.
- When connecting an iPhone to this unit, keep the iPhone at least 20 cm away from this unit. If the iPhone is kept closer to this unit and a telephone call is received by the iPhone, noise may be output from this device.

- iPod recharging occurs whenever an iPod is connected to this unit. (Recharging is enabled only when the unit's power is turned on.)
- For instructions on playing the iPod, see [Playing an iPod on page 30](#).

Connecting a USB device

It is possible to play audio and photo files by connecting USB devices to this receiver.

- ▶ **Switch the receiver into standby then connect your USB device to the iPod/iPhone terminals on the front panel of this receiver.**
- This receiver does not support a USB hub.
- For instructions on playing the USB device, see [Playing a USB device on page 31](#).

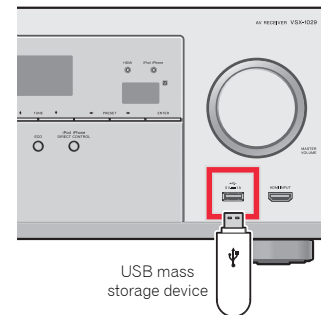

Connecting a MHL-compatible device

An MHL-compatible mobile device can be connected to enjoy full-HD videos, high quality multi-channel audio, and photos etc., with charge the battery on the receiver. Use the MHL cable (sold separately) to connect the device.

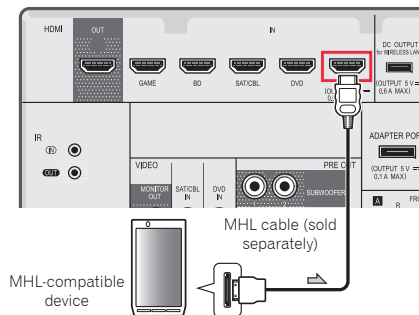

- ▶ **Switch the receiver into standby then use the MHL cable (sold separately) to connect your MHL enabled device to the MHL terminal on the front panel of this receiver.**

- The MHL-compatible device is recharged whenever it is connected to this unit. (Recharging is enabled only when the unit's power is turned on.)
- For instructions on playing the MHL-compatible device, see [Playing a MHL-compatible device on page 33](#).

Note

- Do not place the MHL device on this unit which has the power turned ON.

Enjoy Roku video streaming service

Connect the Roku Streaming Stick (sold separately) to the **MHL** terminal on the receiver to enjoy video streaming, see [Enjoy Roku video streaming service on page 33](#).

- When the Roku Streaming Stick (sold separately) is connected to the receiver via the **MHL** terminal, and the power switched on for the first time, a setup screen will be displayed. Setup can be changed later on as well, see [Setup ROKU standby mode on page 56](#).
- When the Roku Streaming Stick (sold separately) is inserted, the unit will switch to **MHL** input.

Connecting an HDMI-equipped component to the front panel input

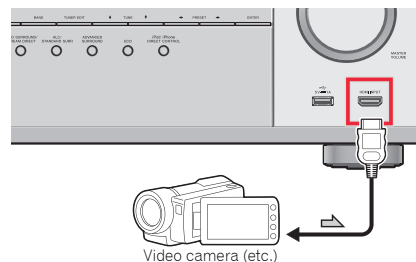

Plugging in the receiver

Only plug in after you have connected all your components to this receiver, including the speakers.

- ▶ **Plug the AC power cord into a convenient AC power outlet.**

CAUTION

- Handle the power cord by the plug. Do not pull out the plug by tugging the cord and never touch the power cord when your hands are wet as this could cause a short circuit or electric shock. Do not place the unit, a piece of furniture, etc., on the power cord, or pinch the cord. Never make a knot in the cord or tie it with other cords. The power cords should be routed such that they are not likely to be stepped on. A damaged power cord can cause a fire or give you an electrical shock. Check the power cord once in a while. When you find it damaged, ask your nearest PIONEER authorized service center or your dealer for a replacement.
- The receiver should be disconnected by removing the mains plug from the wall socket when not in regular use, e.g., when on vacation.

Note

- After this receiver is connected to an AC outlet, a 2 second to 10 second HDMI initialization process begins. You cannot carry out any operations during this process. The **HDMI** indicator in the front panel display blinks during this process, and you can turn on this receiver once it has stopped blinking. When you set the **Control** with **HDMI** to **OFF**, you can skip this process. For details about the **Control** with **HDMI** feature, see [HDMI Setup on page 59](#).

Automatically setting up for surround sound (MCACC)

The Auto Multi-Channel Acoustic Calibration (MCACC) setup measures the acoustic characteristics of your listening area, taking into account ambient noise, speaker size and distance, and tests for both channel delay and channel level. After you have set up the microphone provided with your system, the receiver uses the information from a series of test tones to optimize the speaker settings and equalization for your particular room.

CAUTION

- The test tones used in the Auto MCACC setup are output at high volume.

Important

- The OSD will not appear if you have connected using the composite output to your TV. Use HDMI connection for Auto MCACC setup.
- The Auto MCACC setup will overwrite any existing speaker settings you've made.
- Before using the Auto MCACC setup, the **NETRADIO**, **PANDORA**, **M.SERVER**, **FAVORITE**, **iPod/USB** or **ADAPTER** input should not be selected as an input source.
- VSX-1029 only:* When both the surround back speaker and the front height speaker are connected, conduct Auto MCACC setup twice: once with the Speaker System setting is in **Surr.Back** and once with the Speaker System setting is in **Height**. (There is no need to conduct Auto MCACC setup every time the Speaker System setting is changed.)

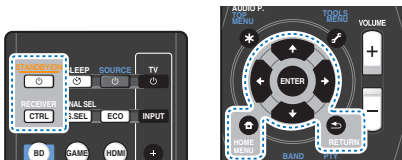

- Switch on the receiver and your TV.
- Switch the TV input to the input that connects this receiver to the TV through the corresponding HDMI cable.
- Connect the microphone to the MCACC SETUP MIC jack on the front panel.

Make sure there are no obstacles between the speakers and the microphone.

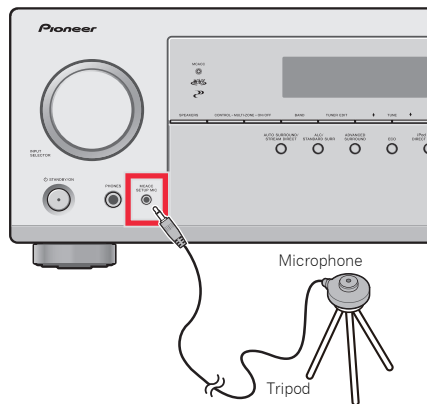

If you have a tripod, use it to place the microphone so that it's about ear level at your normal listening position. Otherwise, place the microphone at ear level using a table or a chair.

- Press **BD** button on the remote control to switch to **BD** entry.

- Press **RECEIVER** on the remote control, then press the **HOME MENU** button.

The Home Menu appears on your TV. Use **↑/↓/←/→** and **ENTER** on the remote control to navigate through the screens and select menu items. Press **RETURN** to exit the current menu.

- Press **HOME MENU** at any time to exit the Home Menu. If you cancel the Auto MCACC setup at any time, the receiver automatically exits and no settings will be made.
- The screensaver automatically starts after three minutes of inactivity.

- Select 'Auto MCACC' from the Home Menu, then press **ENTER**.

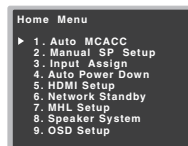

VSX-1029

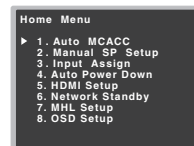

VSX-824

- Mic Int** blinks when the microphone is not connected to MCACC SETUP MIC jack.

Try to be as quiet as possible after pressing **ENTER**. The system outputs a series of test tones to establish the ambient noise level.

- Follow the instructions on-screen.

- Make sure the microphone is connected.
- Make sure the subwoofer is on and the volume is turned up.
- When using surround back or front height speakers, turn on the power to the amplifier to which the surround back or front height speakers are connected, and adjust the sound level to the desired level (VSX-1029 only).
- See below for notes regarding background noise and other possible interference.

8 Wait for the test tones to finish.

A progress report is displayed on-screen while the receiver outputs test tones to determine the speakers present in your setup. Try to be as quiet as possible while it's doing this.

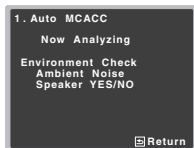

- For correct speaker settings, do not adjust the volume during the test tones.

9 Confirm the speaker configuration.

The configuration shown on-screen should reflect the actual speakers you have.

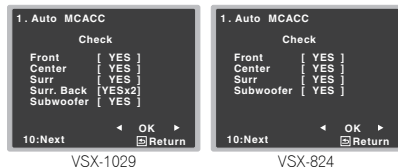

- With error messages (such as **Too much ambient noise**) select **RETRY** after checking for ambient noise (see [Other problems when using the Auto MCACC setup below](#)).

If the speaker configuration displayed isn't correct, use \uparrow/\downarrow to select the speaker and \leftarrow/\rightarrow to change the setting. When you're finished, go to the next step. If you see an error message (**ERR**) in the right side column, there may be a problem with the speaker connection. If selecting **RETRY** doesn't fix the problem, turn off the power and check the speaker connections.

10 Make sure 'OK' is selected, then press ENTER.

If the screen in step 9 is left untouched for 10 seconds and **ENTER** is not pressed in step 10, the Auto MCACC setup will start automatically as shown.

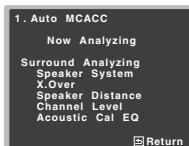

A progress report is displayed on-screen while the receiver outputs more test tones to determine the optimum receiver settings for channel level, speaker distance, X.Over, and Acoustic Calibration EQ. Again, try to be as quiet as possible while this is happening. It may take 1 to 3 minutes.

11 The Auto MCACC setup has finished! You return to the Home Menu.

The settings made in the Auto MCACC setup should give you excellent surround sound from your system, but it is also possible to adjust these settings manually using the Home Menu (starting on [page 53](#)).

Note

- Depending on the characteristics of your room, sometimes identical speakers with cone sizes of around 12 cm (5 inches) will end up with different size settings. You can correct the setting manually using the [Speaker Setting on page 53](#).
- The subwoofer distance setting may be farther than the actual distance from the listening position. This setting should be accurate (taking delay and room characteristics into account) and generally does not need to be changed.

Other problems when using the Auto MCACC setup

If the room environment is not optimal for the Auto MCACC setup (too much background noise, echo off the walls, obstacles blocking the speakers from the microphone) the final settings may be incorrect. Check for household

appliances (air conditioner, fridge, fan, etc.), that may be affecting the environment and switch them off if necessary. If there are any instructions showing in the front panel display, please follow them.

- Some older TVs may interfere with the operation of the microphone. If this seems to be happening, switch off the TV when doing the Auto MCACC setup.



Playing a source

Here are the basic instructions for playing a source (such as a DVD disc) with your home theater system.

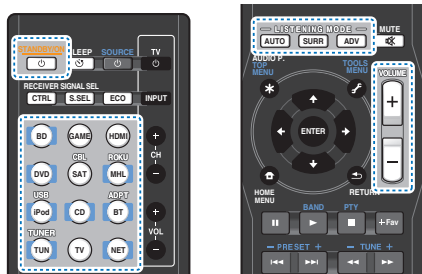

1 Switch on your system components and receiver.

Start by switching on the playback component (for example a DVD player), your TV and subwoofer (if you have one), then the receiver (press **STANDBY/ON**),

- Make sure the setup microphone is disconnected.

2 Switch the TV input to the input that connects this receiver.

For example, if you connected this receiver to the **VIDEO** jacks on your TV, make sure that the **VIDEO** input is now selected.

3 Press input function buttons to select the input function you want to play.

- The input of the receiver will switch over, and you will be able to operate other components using the remote control. To operate the receiver, first press **RECEIVER** on the remote control, then press the appropriate button to operate.
- The input source can also be selected by using the front panel **INPUT SELECTOR** dial. In this case, the remote control won't switch operational modes.

If you selected the proper input source and there is still no sound, select the audio input signal for playback (see [Selecting the audio input signal below](#)).

4 Press **AUTO** to select 'AUTO SURROUND' and start playback of the source.

If you're playing a Dolby Digital or DTS surround sound DVD disc, with a digital audio connection, you should hear surround sound. If you're playing a stereo source or if the connection is an analog audio connection, you will only hear sound from the front left/right speakers in the default listening mode.

It is possible to check on the front panel display whether or not surround sound playback is being performed properly.

When using a surround back speaker, **D+PLIIx** (VSX-1029 only) and **D+PLII** are displayed when playing Dolby Digital 5.1-channel signals, and **DTS+NEO:6** is displayed when playing DTS 5.1-channel signals.

When not using a surround back speaker, **D** is displayed when playing Dolby Digital signals. If the display does not correspond to the input signal and listening mode, check the connections and settings.

Note

- You may need to check the digital audio output settings on your DVD player or digital satellite receiver. It should be set to output Dolby Digital, DTS and 88.2 kHz/96 kHz PCM (2 channel) audio, and if there is an MPEG audio option, set this to convert the MPEG audio to PCM.
- Depending on your DVD player or source discs, you may only get digital 2 channel stereo and analog sound. In this case, the receiver must be set to a multichannel listening mode if you want multichannel surround sound.

5 Use **VOLUME +/-** to adjust the volume level.

Turn down the volume of your TV so that all sound is coming from the speakers connected to this receiver.

Selecting the audio input signal

The audio input signal can be selected for each input source. Once it is set, the audio input that was selected will be applied whenever you select the input source using the input function buttons.



Press **SIGNAL SEL** to select the audio input signal corresponding to the source component.

Each press cycles through the following:

- **H** – Selects an HDMI signal. **H** can be selected for **BD**, **DVD**, **SAT/CBL**, **MHL** or **GAME** input. For other inputs, **H** cannot be selected.
- When the **HDMI** option in [Setting the Audio options on page 39](#) is set to **THRU**, the sound will be heard through your TV, not from this receiver.
- **A** – Selects the analog inputs.
- **C1/O1** – Selects the digital input. The coaxial 1 input is selected for **C1**, and the optical 1 audio input is selected for **O1**.

When **H** (HDMI) or **C1/O1** (digital) is selected and the selected audio input is not provided, **A** (analog) is automatically selected.

Note

- **BD**, **MHL** and **GAME** inputs are fixed to **H** (HDMI). It cannot be changed.
- For the **TV** input, only **A** (analog) or **C1/O1** (digital) can be selected. However, if the **ARC at HDMI Setup** is set to **ON**, the input is fixed to **H** (HDMI) and cannot be changed.
- When set to **H** (HDMI) or **C1/O1** (digital), **D** lights when a Dolby Digital signal is input, and **DTS** lights when a DTS signal is input.
- When the **H** (HDMI) is selected, the **A** and **DIGITAL** indicators are off (see [page 10](#)).

- When digital input (optical or coaxial) is selected, this receiver can only play back Dolby Digital, PCM (32 kHz to 96 kHz) and DTS (including DTS 96 kHz/24 bit) digital signal formats. The compatible signals via the HDMI terminals are: Dolby Digital, DTS, SACD (DSD 2 ch only), PCM (32 kHz to 192 kHz sampling frequencies), Dolby TrueHD, Dolby Digital Plus, DTS-EXPRESS, DTS-HD Master Audio and DVD Audio (including 192 kHz). With other digital signal formats, set to **A** (analog).
- You may get digital noise when a LD or CD player compatible with DTS is playing an analog signal. To prevent noise, make the proper digital connections ([page 19](#)) and set the signal input to **C1/O1** (digital).
- Some DVD players don't output DTS signals. For more details, refer to the instruction manual supplied with your DVD player.

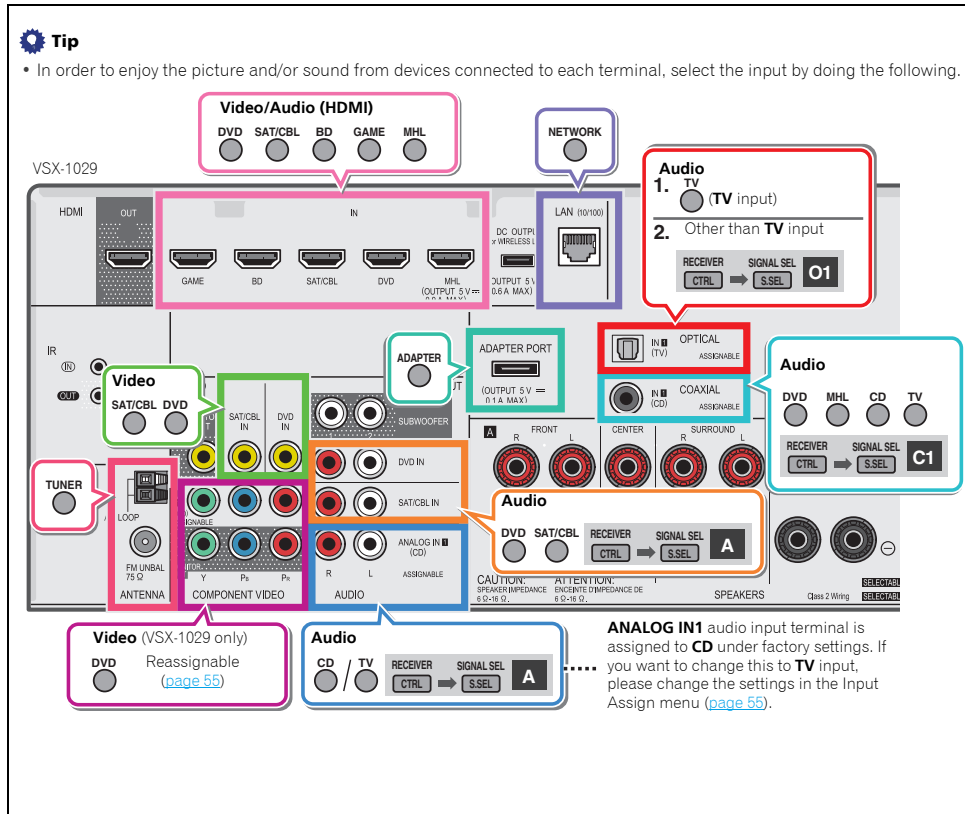



Tip

- In order to enjoy the picture and/or sound from devices connected to each terminal, select the input by doing the following.

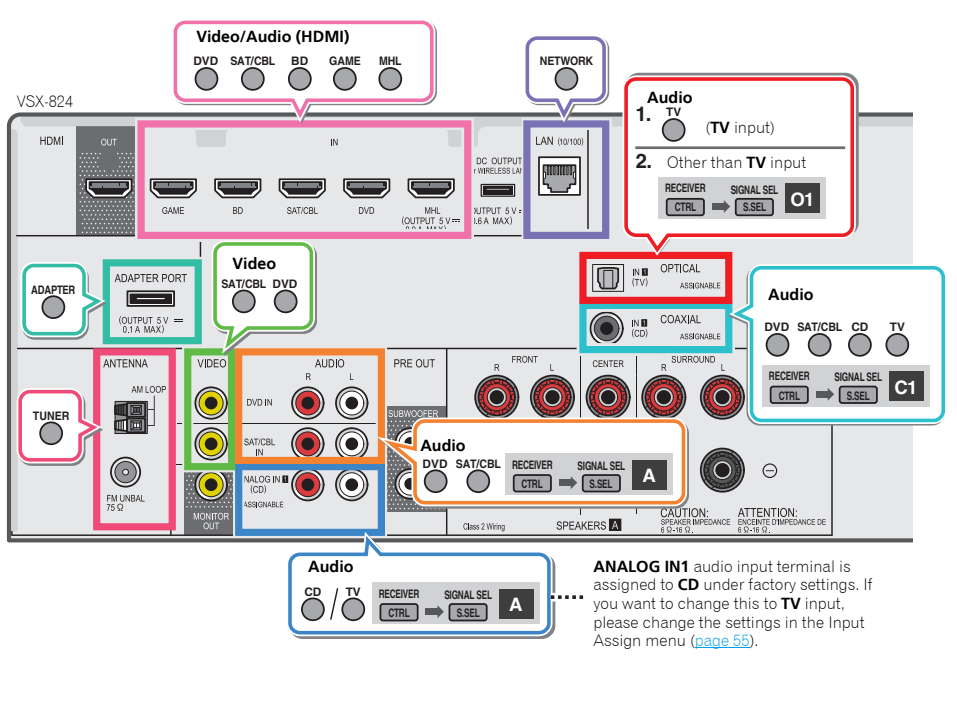

Playing an iPod

This receiver has the **iPod iPhone USB** terminal that will allow you to control playback of audio content from your iPod using the controls of this receiver.

Important

- Pioneer cannot under any circumstances accept responsibility for any direct or indirect loss arising from any inconvenience or loss of recorded material resulting from the iPod failure.
- About one minute is required between turning the power on and completion of startup.
- USB works with iPhone 5s, iPhone 5c, iPhone 5, iPhone 4s, iPhone 4, iPhone 3GS, iPhone 3G, iPhone, iPod touch (1st through 5th generation) and iPod nano (3rd through 7th generation). However, some of the functions may be restricted for some models.
- This receiver has been developed and tested for the software version of iPod/iPhone indicated on the website of Pioneer (<http://pioneer.jp/homeav/support/ios/na/>).
- Installing software versions other than indicated on the website of Pioneer to your iPod/iPhone may result in incompatibility with this receiver.
- iPod and iPhone are licensed for reproduction of non-copyrighted materials or materials the user is legally permitted to reproduce.
- Features such as the equalizer cannot be controlled using this receiver, and we recommend switching the equalizer off before connecting.
- Make sure the receiver is in standby when disconnecting the iPod/iPhone.

1 Switch on the receiver and your TV.

See [Connecting an iPod on page 24](#).

2 Switch the TV input so that it connects to the receiver.

- Switch the TV input to the input that connects this receiver to the TV through the corresponding HDMI cable.

3 Press iPod USB to switch the receiver to the iPod/USB input.

When the display shows the names of folders and files, you're ready to play music from the iPod.

- If after pressing **iPod USB** the display shows **NO DEVICE**, try switching off the receiver and reconnecting the iPod to the receiver.
- The controls of your iPod will be inoperable when connected to this receiver.

Playing back files stored on an iPod

To navigate songs on your iPod, you can take advantage of the OSD of your TV connected to this receiver.

- Note that non-roman characters in the title are displayed as #.
- This feature is not available for photos or video clips on your iPod.

Finding what you want to play

When your iPod is connected to this receiver, you can browse songs stored on your iPod by playlist, artist, album name, song name, genre or composer, similar to using your iPod directly.

- 1 Use **↑/↓** to select a category, then press **ENTER** to browse that category.
 - When **◀◀** or **▶▶** is pressed at the list screen, the page switches.
 - To return to the previous level any time, press **RETURN**.
- 2 Use **↑/↓** to browse the selected category (e.g., albums).
 - Use **◀/▶** to move to previous/next levels.
- 3 Continue browsing until you arrive at what you want to play, then press **▶** to start playback.

Tip

- If you're in the song category, you can also press **ENTER** to start playback.
- You can play all of the songs in a particular category by selecting the **All** item at the top of each category list. For example, you can play all the songs by a particular artist.

Basic playback controls

This receiver's remote control buttons can be used for basic playback of files stored on an iPod.

- Press **iPod USB** to switch the remote control to the iPod/USB operation mode.

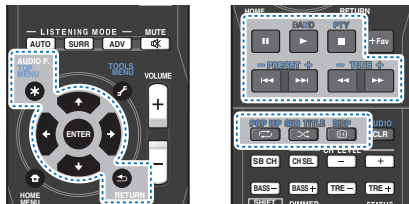

Switches between the iPod controls and the receiver controls

This allows you to switch between performing iPod operations via the receiver remote control or on the iPod itself.

- ▶ Press **HOME MENU** to switch to the iPod controls.
 - Press **HOME MENU** again to switch back to the receiver controls when you're done.

Tip

- Change the receiver's input to the iPod in one action by pressing **iPod iPhone DIRECT CONTROL** on the front panel to enable **iPod** operations on the iPod.

Playing a USB device

It is possible to play files using the USB interface on the front of this receiver.

Important

- Pioneer cannot guarantee compatibility (operation and/or bus power) with all USB mass storage devices and assumes no responsibility for any loss of data that may occur when connected to this receiver.
- About one minute is required between turning the power on and completion of startup.

Note

- Compatible USB devices include external magnetic hard drives, portable flash memory (particularly keydrives) and digital audio players (MP3 players) of format FAT16/32.
- Copyrighted audio files cannot be played back on this receiver.
- With large amounts of data, it may take longer for the receiver to read the contents of a USB device.
- If the file selected cannot be played back, this receiver automatically skips to the next file playable.
- When the file currently being played back has no title assigned to it, the file name is displayed in the OSD instead; when neither the album name nor the artist name is present, the row is displayed as a blank space.
- Note that non-roman characters in the playlist are displayed as '#'.
- Make sure the receiver is in standby when disconnecting the USB device.

- 1 Switch on the receiver and your TV. See [Connecting a USB device on page 24](#).
- 2 Switch the TV input so that it connects to the receiver.
 - Switch the TV input to the input that connects this receiver to the TV through the corresponding HDMI cable.
- 3 Press **iPod USB** on the remote control to switch the receiver to the iPod/USB input.

When the display shows the names of folders and files, you're ready to play from the USB device.

If a **USB Error** message lights in the display, try following the points below:

- Switch the receiver off, then on again.
- Reconnect the USB device with the receiver switched off.
- Select another input source (like **BD**), then switch back to **iPod/USB**.
- Use a dedicated AC adapter (supplied with the device) for USB power.

If this doesn't remedy the problem, it is likely your USB device is incompatible.



Playing back audio files stored on a USB memory device

The maximum number of levels that you can select in Step 1 (below) is 9.

- Note that non-Roman characters in the playlist are displayed as '#'.

1 Use \uparrow/\downarrow to select a folder, then press ENTER to browse that folder.

- To return to the previous level any time, press RETURN.

2 Continue browsing until you arrive at what you want to play, then press \blacktriangleright to start playback.

Basic playback controls

This receiver's remote control buttons can be used for basic playback of files stored on USB devices.

- Press **iPod USB** to switch the remote control to the iPod/USB operation mode.

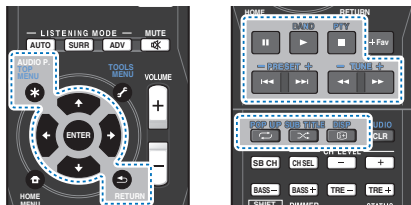

Playing back photo files stored on a USB memory device

1 Use \uparrow/\downarrow to select a folder, then press ENTER to browse that folder.

- For high resolution files, some time may be required for the photo to appear.
- To return to the previous level any time, press RETURN.

2 Continue browsing until you arrive at what you want to play, then press \blacktriangleright to start playback.

The selected content is displayed in full screen and a slideshow starts.

Basic playback controls

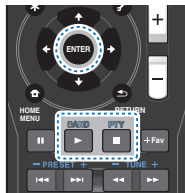

ENTER \blacktriangleright – Starts displaying a photo and playing a slideshow.

■ – Stops the player and returns to the previous menu.

Tip

- Slideshows of photo files can be played while listening to music files by returning to the folder/file list display while playing a music file on a USB device then playing the photo files.

About playable file formats

The USB function of this receiver supports the following file formats. Note that some file formats are not available for playback although they are listed as playable file formats. With MP3, WAV, AAC, FLAC, AIFF and Apple Lossless files, when music files with the same format, sampling frequency, quantization bit number and number of channels are played successively, they are played with no gap.

- Make sure the gap is at the minimum when using MP3 or AAC. If you are concerned about the gap, please use WAV or FLAC files.

Music files

Extension Stream

MP3 (MPEG-1 Audio Layer 3)

.mp3 ^a	Sampling frequency	32 kHz, 44.1 kHz, 48 kHz
	Quantization bitrate	16 bit
	Channel	2 ch
	Bitrate	8 kbps to 320 kbps
	VBR/CBR	Supported/Supported

WAV (LPCM)

.wav	Sampling frequency	32 kHz, 44.1 kHz, 48 kHz, 88.2 kHz, 96 kHz, 176.4 kHz, 192 kHz
	Quantization bitrate	16 bit, 24 bit
	Channel	2 ch

WMA (WMA2/7/8/9)

.wma ^b	Sampling frequency	32 kHz, 44.1 kHz, 48 kHz
	Quantization bitrate	16 bit
	Channel	2 ch
	Bitrate	5 kbps to 320 kbps
	VBR/CBR	Supported/Supported

AAC (MPEG-4 AAC LC, MPEG-4 HE AAC)

.m4a .aac .3gp .3g2	Sampling frequency	32 kHz, 44.1 kHz, 48 kHz
	Quantization bitrate	16 bit
	Channel	2 ch
	Bitrate	16 kbps to 320 kbps
	VBR/CBR	Supported/Supported

FLAC

.flac ^c	Sampling frequency	32 kHz, 44.1 kHz, 48 kHz, 88.2 kHz, 96 kHz, 176.4 kHz, 192 kHz
	Quantization bitrate	16 bit, 24 bit
	Channel	2 ch

AIFF

.aif .aiff	Sampling frequency	32 kHz, 44.1 kHz, 48 kHz, 88.2 kHz, 96 kHz, 176.4 kHz, 192 kHz
	Quantization bitrate	16 bit, 24 bit
	Channel	2 ch

Apple Lossless

.m4a .mp4	Sampling frequency	32 kHz, 44.1 kHz, 48 kHz, 88.2 kHz, 96 kHz
	Quantization bitrate	16 bit, 24 bit
	Channel	2 ch

- a. MPEG Layer-3 audio decoding technology licensed from Fraunhofer IIS and Thomson multimedia.
- b. Files encoded using Windows Media Codec 9 may be playable but some parts of the specification are not supported; specifically, Pro, Lossless, Voice.
- c. Uncompressed FLAC files are not supported. Pioneer does not guarantee playback.

Photo files

Extension	Format
JPEG	
.jpg	Meeting the following conditions: <ul style="list-style-type: none"> • Baseline JPEG format • Y:Cb:Cr – 4:2:2

Note

- When playing a music file while doing a slide show, make sure the contents are less than 48 kHz.

Playing a MHL-compatible device

MHL (Mobile High-definition Link) is an interface standard for transmitting digital signals with mobile devices. MHL can carry high quality multi-channel audio data and full-HD video formats.

The MHL-compatible device's video signals are output from the TV connected to the receiver, the audio signals are output from the speakers connected to the receiver or TV.

1 Press **STANDBY/ON** to switch on the receiver and your TV.

See [Connecting a MHL-compatible device on page 25](#).

2 Press **MHL ROKU** on the remote control to switch the receiver to the MHL.

3 Select and play the desired contents on the MHL-compatible device.

Note

- MHL-compatible devices can be operated with the receiver's remote control by pressing the remote control's **MHL ROKU** button, but depending on the MHL-compatible device being used, some buttons may not be operable.
- To playback from a MHL-compatible device connected to the receiver on a TV that is also connected to the receiver, the power to the receiver must be turned on.

Enjoy Roku video streaming service

Connect the Roku Streaming Stick (sold separately) to the **MHL** terminal on the main device to enjoy video streaming.

1 Press **STANDBY/ON** to switch on the receiver and your TV.

See [Connecting a MHL-compatible device on page 25](#).

2 Press **MHL ROKU** on the remote control to switch the receiver to the MHL.

3 Select the contents you want to play and playback.

Note

- When the Roku Streaming Stick (sold separately) is connected to the main device via the **MHL** terminal, and the power switched on for the first time, a setup screen will be displayed. Setup can be changed later on as well, see [Setup ROKU standby mode on page 56](#).



Bluetooth® ADAPTER for Wireless Enjoyment of Music



Bluetooth wireless technology enabled device:
cell phone



Bluetooth wireless technology enabled device:
Digital music player



Device not equipped with Bluetooth wireless technology: Digital music player + Bluetooth audio transmitter (sold commercially)

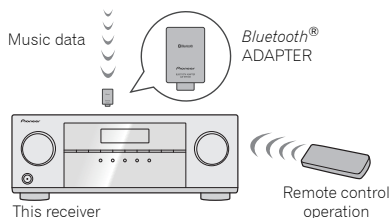

Wireless music play

When the Bluetooth ADAPTER (Pioneer Model No. AS-BT100 or AS-BT200) is connected to this unit, a product equipped with Bluetooth wireless technology (portable cell phone, digital music player, etc.) can be used to listen to music wirelessly. Also, by using a commercially available transmitter supporting Bluetooth wireless technology, you can listen to music on a device not equipped with Bluetooth wireless technology. The AS-BT100 and AS-BT200 model supports SCMS-T contents protection, so music can also be enjoyed on devices equipped with SCMS-T type Bluetooth wireless technology.

- It must be necessary that the Bluetooth wireless technology enabled device supports A2DP profiles.

Important

- Pioneer does not guarantee proper connection and operation of this unit with all Bluetooth wireless technology enabled devices.
- About one minute is required between turning the power on and completion of startup.

Remote control operation

The remote control supplied with this unit allows you to play and stop media, and perform other operations.

- It must be necessary that the Bluetooth wireless technology enabled device supports AVRCP profiles.
- Remote control operations cannot be guaranteed for all Bluetooth wireless technology enabled devices.

Pairing the Bluetooth ADAPTER and Bluetooth wireless technology device

"Pairing" must be done before you start playback of Bluetooth wireless technology content using Bluetooth ADAPTER. Make sure to perform pairing first time you operate the system or any time pairing data is cleared. "Pairing" is the step necessary to register Bluetooth wireless technology device to enable Bluetooth communications. For more details, see also the operating instructions of your Bluetooth wireless technology device.

- Pairing is required when you first use Bluetooth wireless technology device and Bluetooth ADAPTER.
- To enable Bluetooth communication, pairing should be done with both of your system and Bluetooth wireless technology device.
- If the Bluetooth wireless technology device's security code is "0000", there is no need to make the security code setting on the receiver. Press **BT ADPT** to switch the **ADAPTER** input, then conduct the pairing operation on the Bluetooth wireless technology device. If pairing is successful, there is no need to performing the pairing operation below.
- When using the AS-BT200 only: This unit complies with Bluetooth Specifications Ver. 2.1. When this unit and another device equipped with Bluetooth wireless technology both comply with Bluetooth Specification Ver. 2.1, pairing of the two may be possible without the need for inputting a password.

In this case, a passcode may be displayed on this receiver and on the device equipped with Bluetooth wireless technology. If this happens, check that the same passcode is displayed on this receiver and the device equipped with Bluetooth wireless technology, then press **ENTER**. After this, also perform the connection operation on the Bluetooth device to be connected. If the passcode does not match the code displayed on the Bluetooth device to be connected, press **RETURN** to cancel pairing, then try starting over.

Press **BT ADPT** to set the **ADAPTER** input, then conduct the pairing operation on the Bluetooth wireless technology device. If pairing is successful, there is no need to performing the pairing operation below.

- Pair one unit at a time.
- When connecting this receiver by Bluetooth connections with a device equipped with the Bluetooth function to listen to music, do not connect any devices other than this receiver by Bluetooth connection to the Bluetooth-equipped device. If a Bluetooth connection is already established with a device other than this receiver, disconnect the other device before connecting this receiver.

- Press **BT ADPT** to switch the receiver to **ADAPTER** input.
- Press **TOP MENU** to select **Bluetooth Setup**.
- Use **↑/↓** to select **PIN**, then press **ENTER**.
- Use **↑/↓** to select one of **PIN** codes **0000**, **1234** or **8888**, then press **ENTER**.

You can use any of **0000/1234/8888** PIN codes. Bluetooth wireless technology device using any other PIN code cannot be used with this system.

- Switch on the **Bluetooth** wireless technology device that you want to make pairing, place it near the system and set it into the pairing mode.
- Check to see that the **Bluetooth ADAPTER** is detected by the **Bluetooth** wireless technology device.

When Bluetooth wireless technology device is connected: Bluetooth wireless technology device name appears in the receiver display.

- The system can display alphanumeric characters only. Other characters may not be displayed correctly.



When *Bluetooth* wireless technology device is not connected:

WAITING appears in the receiver display. In this case, perform the connection operation from the side of the *Bluetooth* wireless technology device.

7 From the *Bluetooth* wireless technology device list, select *Bluetooth* ADAPTER and enter the PIN code selected in the step 4.

- PIN code may in some case be referred to as PASSKEY.

Listening to Music Contents of *Bluetooth* wireless technology device with Your System

1 Press BT ADPT to switch the receiver to ADAPTER input.

2 Perform the connection operation from the side of the *Bluetooth* wireless technology device to the *Bluetooth* ADAPTER.

- When the *Bluetooth* ADAPTER is not plugged into the **ADAPTER PORT** terminal, **NO ADP** will be displayed if **ADAPTER** input is selected.

3 Start playback of music contents stored in *Bluetooth* wireless technology device.

This receiver's remote control buttons can be used for basic playback of files stored on the *Bluetooth* wireless technology device.

- *Bluetooth* wireless technology device should be compatible with AVRCP profile.
- Depending on *Bluetooth* wireless technology device you use, operation may differ from what is shown in the remote control buttons.

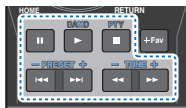

4 While listening to a source, press RECEIVER then press ADV repeatedly to select S.R AIR.

The *Bluetooth*® word mark and logos are registered trademarks owned by Bluetooth SIG, Inc. and any use of such marks by PIONEER CORPORATION is under license. Other trademarks and trade names are those of their respective owners.

Note

- With this receiver, when an iPod is connected or disconnected while the music of a *Bluetooth* wireless technology device is playing, the connection with the *Bluetooth* wireless technology device may be canceled.



Listening to the radio

The following steps show you how to tune in to FM and AM radio broadcasts using the automatic (search) and manual (step) tuning functions. Once you are tuned to a station you can memorize the frequency for recall later—see [Saving station presets below](#) for more on how to do this.

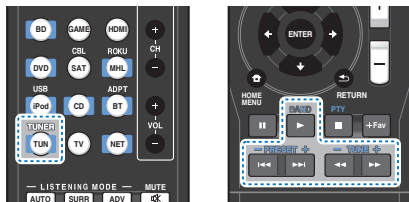

1 Press **TUNER** to select the tuner.

2 Use **BAND** to change the band (FM or AM), if necessary. Each press switches the band between FM (stereo or mono) and AM.

3 Tune to a station.

There are three ways to do this:

❖ Automatic tuning

To search for stations in the currently selected band, press and hold **TUNE +/-** for about a second. The receiver will start searching for the next station, stopping when it has found one. Repeat to search for other stations.

❖ Manual tuning

To change the frequency one step at a time, press **TUNE +/-**.

❖ High speed tuning

Press and hold **TUNE +/-** for high speed tuning.

Improving FM sound

If the **TUNE** or **ST** indicators don't light when tuning to an FM station because the signal is weak, set the receiver to the mono reception mode.

▶ Press **BAND** to select **FM MONO**.

This should improve the sound quality and allow you to enjoy the broadcast.

Saving station presets

If you often listen to a particular radio station, it's convenient to have the receiver store the frequency for easy recall whenever you want to listen to that station. This saves the effort of manually tuning in each time. This unit can memorize up to 30 stations.

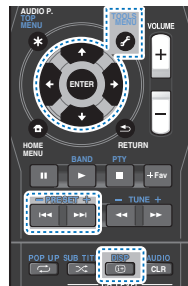

1 Tune to a station you want to memorize.

See [Listening to the radio above](#) for more on this.

2 Press **TOOLS**.

The display shows **PRESET**, then a blinking **MEM** and station preset.

3 Press **PRESET +/-** to select the station preset you want.

You can also use the number buttons.

4 Press **ENTER**.

The preset number stop blinking and the receiver stores the station.

Note

- If the receiver is left disconnected from the AC power outlet for over a month, the station memories will be lost and will have to be reprogrammed.
- Stations are stored in stereo. When the station is stored in the FM MONO mode, it shows as **ST** when recalled.

Listening to station presets

You will need to have some presets stored to do this. See [Saving station presets above](#) if you haven't done this already.

▶ Press **PRESET +/-** to select the station preset you want.

- You can also use the number buttons on the remote control to recall the station preset.

Naming preset stations

For easier identification, you can name all of your preset stations.

1 Choose the station preset you want to name.

See [Listening to station presets above](#) for how to do this.

2 Press **TOOLS** twice.

The cursor at the first character position is blinking on the display.

3 Input the name you want.

Choose a name up to eight characters long.

- Use **←/→** to select character position.
- Use **↑/↓** to select characters.
- The name is stored when **ENTER** is pressed.

Tip

- To erase a station name, follow steps 1 and 2, and press **ENTER** while the display is blank. Press **TOOLS** while the display is blank, to keep the previous name.
- Once you have named a station preset, Press **DISP** to show the name. When you want to return to the frequency display, press **DISP** several times to show the frequency.

Choosing the listening mode

This receiver offers a variety of listening modes to accommodate playback of various audio formats. Choose one according to your speaker environment or the source.

- While listening to a source, press the listening mode button repeatedly to select a listening mode you want.

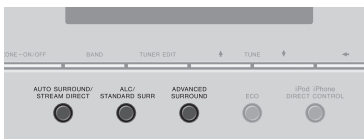
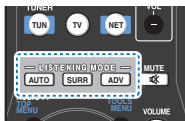

- The listening mode is shown on the display on the front panel.

Important

- The listening modes and many features described in this section may not be available depending on the current source, settings and status of the receiver.

Auto playback



The simplest, most direct listening option is the **AUTO SURROUND** feature. With this, the receiver automatically detects what kind of source you're playing and selects multichannel or stereo playback as necessary.

- Press **AUTO** repeatedly until **AUTO SURROUND** shows briefly in the display (it will then show the decoding or playback format). Check the digital format indicators in the display to see how the source is being processed.

Note

- Stereo surround (matrix) formats are decoded accordingly using **NEO:6 CINEMA** or **DOLBY PLIIx MUSIC** (VSX-1029 only) (see [Listening in surround sound below](#) for more on these decoding formats).
- When listening to the **ADAPTER** input, the **S.R AIR** feature is selected automatically (see [Using the Advanced surround on page 38](#) for more on this).

Listening in surround sound



Using this receiver, you can listen to any source in surround sound. However, the options available will depend on your speaker setup and the type of source you're listening to.

- If the source is Dolby Digital, DTS, or Dolby Surround encoded, the proper decoding format will automatically be selected and shows in the display.

When you select **STEREO ALC** (Auto Level Control stereo mode), this unit equalizes playback sound levels if each sound level varies with the music source recorded in a portable audio player.

When you select **STEREO**, you will hear the source through just the front left and right speakers (and possibly your subwoofer depending on your speaker settings). Dolby Digital and DTS multichannel sources are downmixed to stereo.

The following modes provide basic surround sound for stereo and multichannel sources.

Explanatory notes

No: No connected / Yes: Connected / Two: Two speakers are connected / -: Whether connected or no

Type of surround modes	Suitable sources	Surround back speaker(s) (VSX-1029 only)	Front height speakers (VSX-1029 only)
Two channel sources			
STEREO ALC	See above.	-	-
DOLBY PLIIx MOVIE^g	Movie	Yes ^a	No
DOLBY PLII MOVIE		No	-
DOLBY PLIIx MUSIC^{b, g}	Music	Yes ^a	No
DOLBY PLII MUSIC^b		No	-
DOLBY PLIIx GAME^g	Video games	Yes ^a	No
DOLBY PLII GAME		No	-
DOLBY PLIIz HEIGHT^{c, g}	Movie/Music	No	Yes
NEO:6 CINEMA^d	Movie	-	-
NEO:6 MUSIC^d	Music	-	-
DOLBY PRO LOGIC	Old movies	-	-
Straight Decode ^e	No additional effects	No	-
STEREO^f	See above.	-	-
Multichannel sources			
STEREO ALC	See above.	-	-
DOLBY PLIIx MOVIE^g	Movie	Two	No
DOLBY PLIIx MUSIC^{b, g}	Music	Yes	No
DOLBY DIGITAL EX^g	Movie/Music	Yes	No
DTS-ES^g	Movie/Music	Yes	No
DTS NEO:6^g	Movie/Music	Yes	No
DOLBY PLIIz HEIGHT^g	Movie/Music	No	Yes
Straight Decode ^e	No additional effects	-	-
STEREO^f	See above.	-	-

- If surround back channel processing ([Using surround back channel processing \(VSX-1029 only\) below](#)) is switched off, or the surround back speakers are set to **NO DOLBY PLIIX** becomes **DOLBY PLIIX** (5.1 channel sound).
- You can also adjust the **C.WIDTH**, **DIMEN.**, and **PNRM.** effect (see [Setting the Audio options on page 39](#)).
- In case of *VSX-1029*: You can also adjust the **H.GAIN** effect (see [Setting the Audio options on page 39](#)).
- You can also adjust the **C.IMG** effect (see [Setting the Audio options on page 39](#)).
- In case of *VSX-1029*: Cannot be selected when the **Speaker System** is set to **Surr. Back** (see [The Speaker System setting \(VSX-1029 only\) on page 57](#)).
- The audio is heard with your surround settings and you can still use the Midnight, Loudness, Phase Control, Sound Retriever and Tone functions.
- VSX-1029 only*

Note

- In modes that give 6.1 channel sound, the same signal is heard from both surround back speakers (*VSX-1029 only*).

Using the Advanced surround



The Advanced surround feature creates a variety of surround effects. Try different modes with various soundtracks to see which you like.

ACTION	Designed for action movies with dynamic soundtracks.
DRAMA	Designed for movies with lots of dialog.
ADVANCED GAME	Suitable for video games.
SPORTS	Suitable for sports programs.
CLASSICAL	Gives a large concert hall-type sound.
ROCK/POP	Creates a live concert sound for rock and/or pop music.
EXT.STEREO	Gives multichannel sound to a stereo source, using all of your speakers.
ECO MODE 1	Cut back on power consumption. Suitable for contents that are mainly high level (mainly music).
ECO MODE 2	Cut back on even more power consumption than ECO MODE 1 . Suitable for contents with wider dynamic range (mainly movies).

Note

- During ECO mode, the brightness switches between 2 levels. If the dimmest level is selected, DIMMER will be shown on the display. (Mode other than ECO: 4 levels, ECO mode: 2 levels)
- ECO MODE will switch **OFF** automatically when switched to other listening modes (Advanced surround mode and Auto surround mode).

F.S.S.ADVANCE (Front Stage Surround ADVANCE)

Allows you to create natural surround sound effects using just the front speakers and the subwoofer. Use to provide a rich surround sound effect directed to the center of where the front left and right speakers sound projection area converges.

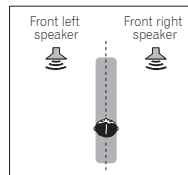

S.R AIR (Sound Retriever AIR)

Suitable for listening to the sound from a *Bluetooth* wireless technology device. The **S.R AIR** listening mode can only selected when the **ADAPTER** input.

PHONES SURR

When listening through headphones, you can still get the effect of overall surround.

Using Stream Direct



Use the Stream Direct modes when you want to hear the truest possible reproduction of a source. All unnecessary signal processing is bypassed.

AUTO SURROUND See [Auto playback on page 37](#).

DIRECT

Sources are heard according to the settings made in the Manual SP Setup (speaker setting, channel level, speaker distance), as well as with dual mono settings. You will hear sources according to the number of channels in the signal. Phase Control, Acoustic Calibration EQ, Sound Delay, Auto Delay, LFE Attenuate and Center image functions are available.

PURE DIRECT

Analog and PCM sources are heard without any digital processing.

Using the Sound Retriever

When audio data is removed during the compression process, sound quality often suffers from an uneven sound image. The Sound Retriever feature employs new DSP technology that helps bring CD quality sound back to compressed 2-channel audio by restoring sound pressure and smoothing jagged artifacts left over after compression. (see [Setting the Audio options on page 39](#)).

Listening with Acoustic Calibration EQ

You can listen to sources using the Acoustic Calibration Equalization set in [Automatically setting up for surround sound \(MCACC\) on page 26](#). Refer to these pages for more on Acoustic Calibration Equalization. (see [Setting the Audio options on page 39](#)).

Using surround back channel processing (VSX-1029 only)

You can have the receiver automatically use 6.1 or 7.1 decoding for 6.1 encoded sources (for example, Dolby Digital EX or DTS-ES), or you can choose to always use 6.1 or 7.1 decoding (for example, with 5.1 encoded material). With 5.1 encoded sources, a surround back channel will be generated, but the material may sound better in the 5.1 format for which it was originally encoded (in which case, you can simply switch surround back channel processing off).

- With a 7.1-channel surround system, audio signals that have undergone matrix decoding processing through surround back channel processing to which the Up Mix function is added are output from the surround back speakers.



Press SB CH repeatedly to cycle the surround back channel options.

Each press cycles through the options as follows:

- SB ON** – Matrix decoding processing for generating the surround back component from the surround component is turned on.
- SB AUTO** – Matrix decoding processing for generating the surround back component from the surround component is switched automatically. Matrix decoding processing is only performed when surround back channel signals are detected in the input signals.
- SB OFF** – Matrix decoding processing for generating the surround back component from the surround component is turned off.

Setting the Up Mix function (VSX-1029 only)

In a 7.1-channel surround system with surround speakers placed directly at the sides of the listening position, the surround sound of 5.1-channel sources is heard from the side. The Up Mix function mixes the sound of the surround speakers with the surround back speakers so that the surround sound is heard from diagonally to the rear as it should be.

- Using the Up Mix function is effective when the speakers in the 7.1-channel surround system are set up as recommended in the example on [page 14](#).

- Depending on the positions of the speakers and the sound source, in some cases it may not be possible to achieve good results. In this case, set the setting to **OFF**.

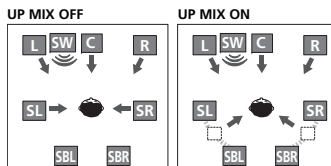

- Switch the receiver into standby.
- While holding down **PRESET** → on the front panel, and hold the **STANDBY/ON** for about two seconds.

UP MIX: OFF appears and the Up Mix function turns off. If you want to turn this function on, perform steps 1 and 2 again.

- When set to **ON**, the (Up Mix) indicator on the front panel lights.

Note

- Set to **ON** regardless of this setting when playing DTS-HD signals.
- May automatically be set to **OFF** even when set to **ON**, depending on the input signal and listening mode.
- If the **Network Standby** is set to **ON** or **Standby Through** is not set to **OFF**, you may not be able to set the Up Mix function.
- HDMI Control should also be set to **OFF**, not **ON**.

Setting the Audio options

There are a number of additional sound settings you can make using the **AUDIO PARAMETER** menu. The defaults, if not stated, are listed in bold.

Important

- Note that if a setting doesn't appear in the **AUDIO PARAMETER** menu, it is unavailable due to the current source, settings and status of the receiver.

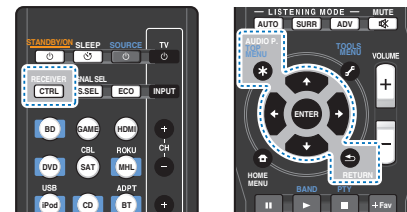

- Press **RECEIVER**, then press **AUDIO P..**
- Use **↑/↓** to select the setting you want to adjust. Depending on the current status/mode of the receiver, certain options may not be able to be selected. Check the table below for notes on this.
- Use **←/→** to set it as necessary. See the table below for the options available for each setting.
- Press **RETURN** to confirm and exit the menu.

Setting/What it does	Option(s)
EQ (Acoustic Calibration EQ) Switches on/off the effect of Acoustic Calibration EQ.	ON <i>OFF</i>
S.DELAY (Sound Delay) Some monitors have a slight delay when showing video, so the soundtrack will be slightly out of sync with the picture. By adding a bit of delay, you can adjust the sound to match the presentation of the video.	<i>0 to 500 ms (1 step : 5 ms)</i> Default: 0
MIDNIGHT/LOUDNESS The MIDNIGHT allows you to hear effective surround sound of movies at low volumes. The LOUDNESS is used to get good bass and treble from music sources at low volumes.	M/L OFF <i>MIDNIGHT</i> <i>LOUDNESS</i>
S.RTV (Sound Retriever) Switches ON/OFF the effect of Sound Retriever.	OFF ^a <i>ON</i>
DUAL MONO ^b Specifies how dual mono encoded Dolby Digital soundtracks should be played.	CH1 – Channel 1 is heard only <i>CH2</i> – Channel 2 is heard only <i>CH1 CH2</i> – Both channels heard from front speakers
F.PCM (Fixed PCM) This is useful if you find there is a slight delay before OFF recognizes the PCM signal on a CD, for instance. When ON is selected, noise may be output during playback of non-PCM sources. Please select another input signal if this is a problem.	OFF <i>ON</i>
DRC (Dynamic Range Control) Adjusts the level of dynamic range for movie soundtracks optimized for Dolby Digital, DTS, Dolby Digital Plus, Dolby TrueHD, DTS-HD and DTS-HD Master Audio (you may need to use this feature when listening to surround sound at low volumes).	AUTO ^c <i>MAX</i> <i>MID</i> <i>OFF</i>

Setting/What it does	Option(s)
LFE ATT (LFE Attenuate) Some Dolby Digital and DTS audio sources include ultra-low bass tones. Set the LFE attenuator as necessary to prevent the ultra-low bass tones from distorting the sound from the speakers. The LFE is not limited when set to 0 dB, which is the recommended value. When set to -15 dB, the LFE is limited by the respective degree. When OFF is selected, no sound is output from the LFE channel.	0 (0 dB) <i>5 (-5 dB)</i> <i>10 (-10 dB)</i> <i>15 (-15 dB)</i> <i>20 (-20 dB)</i> <i>** (OFF)</i>
SACD G. (SACD Gain) ^d Brings out detail in SACDs by maximizing the dynamic range (during digital processing).	0 (0 dB) <i>+6 (+6 dB)</i>
HDMI (HDMI Audio) Specifies the routing of the HDMI audio signal out of this receiver (AMP) or through to a TV (THRU). When THRU is selected, no sound is output from this receiver. The HDMI Audio setting cannot be switched while performing synchronized amp mode operations (page 59).	AMP <i>THRU</i>
A.DLY (Auto Delay) ^e This feature automatically corrects the audio-to-video delay between components connected with an HDMI cable. The audio delay time is set depending on the operational status of the display connected with an HDMI cable. The video delay time is automatically adjusted according to the audio delay time.	OFF <i>ON</i>
PHASE CTRL (Phase Control) ^f Phase Control feature uses phase correction measures to make sure your sound source arrives at the listening position in phase, preventing unwanted distortion and/or coloring of the sound. Phase Control technology provides coherent sound reproduction through the use of phase matching for an optimal sound image at your listening position. The default setting is on and we recommend leaving Phase Control switched on for all sound sources.	ON <i>OFF</i>

Setting/What it does	Option(s)
C.WIDTH (Center Width) ^g (Applicable only when using a center speaker) Spreads the center channel between the front right and left speakers, making it sound wider (higher settings) or narrower (lower settings).	0 to 7 Default: 3
DIMEN (Dimension) ^g Adjusts the surround sound balance from front to back, making the sound more distant (minus settings), or more forward (positive settings).	-3 to +3 Default: 0
PNRM. (Panorama) ^g Extends the front stereo image to include surround speakers for a 'wraparound' effect.	OFF <i>ON</i>
C.IMG (Center Image) ^h (Applicable only when using a center speaker) Adjust the center image to create a wider stereo effect with vocals. Adjust the effect from 0 (all center channel sent to front right and left speakers) to 10 (center channel sent to the center speaker only).	0 to 10 Default: 3 (NEO:6 MUSIC), 10 (NEO:6 CINEMA)
H.GAIN (Height Gain) (VSX-1029 only) Adjusts the output from the front height speaker when listening in DOLBY PLIIz HEIGHT mode. If set to H , the sound from the top will be more emphasized.	<i>L (Low)</i> M (Mid) <i>H (High)</i>

- The default setting when the **iPod/USB, ADAPTER, NETRADIO, PANDORA, M.SERVER** or **FAVORITE** input is selected is **ON**.
- This setting works only with dual mono encoded Dolby Digital and DTS soundtracks.
- The initial set **AUTO** is only available for Dolby TrueHD signals. Select **MAX** or **MID** for signals other than Dolby TrueHD.
- You shouldn't have any problems using this with most SACD discs, but if the sound distorts, it is best to switch the gain setting back to **0** dB.
- This feature is only available when the connected display supports the automatic audio/video synchronizing capability ('lip-sync') for HDMI. If you find the automatically set delay time unsuitable, set **A.DLY** to **OFF** and adjust the delay time manually. For more details about the lip-sync feature of your display, contact the manufacturer directly.



- f. Phase matching is a very important factor in achieving proper sound reproduction. If two waveforms are 'in phase', they crest and trough together, resulting in increased amplitude, clarity and presence of the sound signal. If a crest of a wave meets a trough, then the sound will be 'out of phase' and an unreliable sound image will be produced.

If your subwoofer has a phase control switch, set it to the plus (+) sign (or 0°). However, the effect you can actually feel when Phase Control is set to **ON** on this receiver depends on the type of your subwoofer. Set your subwoofer to maximize the effect. It is also recommended you try changing the orientation or the place of your subwoofer.

Set the built-in lowpass filter switch of your subwoofer to OFF.

If this cannot be done on your subwoofer, set the cutoff frequency to a higher value.

If the speaker distance is not properly set, you may not have a maximized Phase Control effect.

The Phase Control mode cannot be set to **ON** in the following cases:

- When the **PURE DIRECT** mode is switched on.
 - When the headphones are connected.
- g. Only available with 2-channel sources in **DOLBY PLII MUSIC** mode.
- h. Only when listening to 2-channel sources in **NEO:6 CINEMA** and **NEO:6 MUSIC** mode.



Introduction

This receiver is equipped with the LAN terminal and you can enjoy the following features by connecting your components to these terminals.

Listening to Internet radio stations

You can select and listen to your favorite Internet radio station from the list of Internet radio stations created, edited, and managed by the vTuner database service exclusively for use with the Pioneer products.

See [Playback with Network functions on page 43](#) and [Listening to Internet radio stations on page 44](#).

Playback the music files stored in PCs

You can playback a lot of musics stored in your PCs using this unit.

- Besides a PC, you can also play back audio files stored on your other components with the built-in media server function based on DLNA 1.0 or DLNA 1.5 framework and protocols (i.e. network-capable hard disks and audio systems).

See [Playback with Network functions on page 43](#) and [Playing back audio files stored on components on the network on page 45](#).

Listening to Pandora

See [Listening to Pandora Internet Radio on page 44](#).

Using the Spotify audio stream playback function

See [About the Spotify audio stream playback function on page 45](#).

Note

- To listen to Internet radio stations, you must sign a contract with an ISP (Internet Service Provider) beforehand.
- Photo or video files cannot be played back.
- With Windows Media Player 11 or Windows Media Player 12, you cannot play back copyrighted audio files on this receiver.

About playable DLNA network devices

This unit allows you to play music on media servers connected on an identical Local Area Network (LAN) as the receiver. This unit allows for the playing of files stored on the following devices:

- PCs running Microsoft Windows Vista or XP with Windows Media Player 11 installed
- PCs running Microsoft Windows 7 or 8 with Windows Media Player 12 installed
- DLNA-compatible digital media servers (on PCs or other components)

Files stored in a PC or DMS (Digital Media Server) as described above can be played via command from an external Digital Media Controller (DMC). Devices controlled by this DMC to play files are called DMRs (Digital Media Renderers). This receiver supports this DMR function. When in the DMR mode, such operations as playing and stopping files can be performed from the external controller. Volume adjustment and the muting control are also possible.

- Depending on the external controller being used, playback may be interrupted when the volume is adjusted from the controller. In this case, adjust the volume from the receiver or remote control.

Using AirPlay on iPod touch, iPhone, iPad, and iTunes

AirPlay works with iPhone, iPad, and iPod touch with iOS 4.3.3 or later, Mac with OS X Mountain Lion, and Mac and PC with iTunes 10.2.2 or later.

To use AirPlay, select your receiver on your iPod touch, iPhone, iPad or in iTunes. *1

The receiver's input will switch automatically to AirPlay when AirPlay is in use. *2

The following operations can be performed when in AirPlay mode:

- Adjustment of the receiver's volume from iPod touch, iPhone, iPad or iTunes.

- Pause/resume, next/previous track, and shuffle/repeat from the remote control of the receiver. (Press **NET** to switch the remote control to the network operation mode.)

*1: For more information, see the Apple website (<http://www.apple.com>).

*2: The receiver's power automatically turns on when **Network Standby** is set to **ON** ([page 56](#)).

Note

- A network environment is required to use AirPlay.
- AirPlay provided on this receiver has been developed and tested based on the software versions for the iPod, iPhone, iPad and the software versions for iTunes that are indicated on the Pioneer website. AirPlay may not be compatible with iPod, iPhone, iPad or iTunes software versions other than those indicated on the Pioneer website.

About the DHCP server function

To play back audio files stored on components on the network or listen to Internet radio stations, you must turn on the DHCP server function of your router. In case your router does not have the built-in DHCP server function, it is necessary to set up the network manually. Otherwise, you cannot play back audio files stored on components on the network or listen to Internet radio stations. See [The Network Setup menu on page 46](#) for more on this.

Authorizing this receiver

This receiver must be authorized to enable playback. This happens automatically when the receiver makes a connection over the network to the PC. If not, please authorize this receiver manually on the PC. The authorization (or permission) method for access varies depending on the type of server currently being connected. For more information on authorizing this receiver, refer to the instruction manual of your server.



About HTC Connect

This receiver features "HTC Connect", a simple way to enjoy music content from your HTC Connect certified smart phone.

- 1 HTC Connect music streaming provided on this product has been developed based on interoperability testing as defined by the HTC Connect Certification program with the HTC Connect-compatible smartphones.
- 2 Music Navigation via the music progress bar is not currently supported with HTC Connect.
- 3 Third party music applications (those other than HTC's pre-installed "Music" app) have not been tested for compatibility and may not work. HTC Connect has been tested with MP3, AAC, WMA and WAV encoding formats. Other formats may not be compatible.
- 4 High network congestion may interfere with the operation of HTC Connect.

HTC Connect Certified Smartphones

The HTC Connect-compatible smartphones, Please check Pioneer website for up to date information about compatible devices and audio format support.

<http://www.pioneerelectronics.com/htc> (for USA)

<http://www.pioneerelectronics.ca/htc> (for Canada)

Specifications and design subject to modification without notice.

HTC, HTC Connect and the HTC Connect logo are trademarks of HTC Corporation.

Playback with Network functions

Important

- In case a domain is configured in a Windows network environment, you cannot access a PC on the network while you are logged onto the domain. Instead of logging onto the domain, log onto the local machine.
- There are cases where the time elapsed may not be correctly displayed.
- About one minute is required between turning the power on and completion of startup.

1 Press NET repeatedly to select the category you want to play back.

It may take several seconds for this receiver to access the network.

Select a category from the following list:

- **NETRADIO** – Internet radio
 - When **NETRADIO** is selected, the radio station that was playing last time is played.
- **PANDORA** – Internet radio that supports Pandora
- **M.SERVER** – Server components on the network (Media server)
- **FAVORITE** – Favorite songs currently being registered

Depending on the selected category, the names of folders, files, and Internet radio stations are displayed.

2 Use ↑/↓ to select the folder, music files or Internet radio station to play back, and then press ENTER.

Press ↑/↓ to scroll up and down the list and select the desired item. When you press **ENTER**, playback starts with the playback screen being displayed for the selected item. To return to the list screen, press **RETURN**.

When the list screen is displayed from the playback screen, the playback screen reappears automatically if no operation is performed for 180 seconds while the list screen is displayed. Will return to playback screen even if **DISP** button is pressed.

Only audio files with the 🎵 mark can be played. In case of the folders with the □ mark, use ↑/↓ and **ENTER** to select the desired folder and audio files.

- When **◀◀** or **▶▶** is pressed at the list screen, the page switches.

3 Repeat step 2 to play back the desired song.

For detailed operating instructions, refer to the section shown below.

- Internet radio stations – See [Listening to Internet radio stations on page 44](#).
- Pandora – See [Listening to Pandora Internet Radio on page 44](#).
- Media server – See [Playing back audio files stored on components on the network on page 45](#).
- Favorites – See [Playing back your favorite songs on page 45](#).

Basic playback controls

You can perform the following operations with the remote control of this receiver. Note that some buttons are not available for operation depending on the category currently being played back.

▶ Press NET to switch the remote control to the NETRADIO, PANDORA, M.SERVER or FAVORITE operation mode.

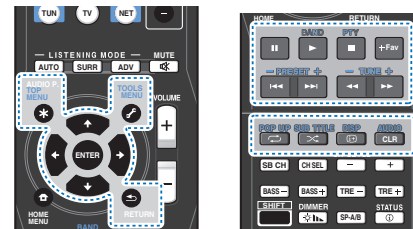

Note

- When selecting input for **M.SERVER** and **FAVORITE**, depending on the server or file:
 - the **II** button will not operate.
 - the **◀◀ ▶▶** button will not operate or will act identical to the **◀◀ ▶▶** button.

- If the **TOOLS** button is pressed for the list displayed screen when selecting input for **M.SERVER**, one can realign the displayed title alphabetically or the track No.

Listening to Internet radio stations

Internet radio is an audio broadcasting service transmitted via the Internet. There are a large number of Internet radio stations broadcasting a variety of services from every corner of the world. Some are hosted, managed, and broadcast by private individuals while others are by the corresponding traditional terrestrial radio stations or radio networks. Whereas terrestrial, or OTA (over-the-air), radio stations are geographically restricted on the range of radio waves broadcast from a transmitter through the air, Internet radio stations are accessible from anywhere in the world, as long as there is a connection to the Internet, as services are not transmitted through the air but are delivered over the World Wide Web. On this receiver you can select Internet radio stations by genre as well as by region. Depending on the Internet line conditions, the sound may not be smooth when playing Internet radio.

About list of Internet radio

The list of Internet radio stations on this receiver is created, edited, and managed by the vTuner database service exclusively for use with this receiver. For details about vTuner, see [vTuner on page 51](#).

Saving and retrieving Internet radio stations

You can easily save and retrieve saved Internet radio stations. See [Playing back your favorite songs on page 45](#) for more on this.

- To listen to Internet radio stations, you must have high-speed broadband Internet access. With a 56 K or ISDN modem, you may not enjoy the full benefits of Internet radio.
- The port number varies depending on the Internet radio station. Check the firewall settings.
- A list of Internet radio stations provided by the vTuner database service is subject to change or deletion without notice due to various reasons.
- Broadcasts may be stopped or interrupted depending on the Internet radio station. In this case, you cannot listen to a radio station selected from the list of Internet radio stations.

Registering broadcast stations not on the vTuner list from the special Pioneer site

With the receiver, broadcast stations not included on the list of station distributed by vTuner can be registered and played. Check the access code required for registration on the receiver, use this access code to access the special Pioneer Internet radio site and register the desired broadcast stations in your favorites. The address of the special Pioneer Internet radio site is:

<http://www.radio-pioneer.com>

- 1 Display the Internet Radio list screen.**
To display the Internet Radio list screen, perform step 1 at [Playback with Network functions on page 43](#).
- 2 Use \uparrow/\downarrow to select 'Help', then press ENTER.**
- 3 Use \uparrow/\downarrow to select 'Get access code', then press ENTER.**

The access code required for registration on the special Pioneer Internet radio site is displayed. Make a memo of this address.

The following can be checked on the **Help** screen:

- **Get access code** – The access code required for registration on the special Pioneer Internet radio site is displayed.
- **Show Your WebID/PW** – After registering on the special Pioneer Internet radio site, the registered ID and password are displayed.
- **Reset Your WebID/PW** – Resets all the information registered on the special Pioneer Internet radio site. When reset, all the registered broadcast stations are also cleared. If you want to listen to the same stations, re-register after resetting.

- 4 Access the special Pioneer Internet radio site from your computer and perform the registration process.**

<http://www.radio-pioneer.com>

Access the above site and use the access code in step 3 to perform user registration, following the instructions on the screen.

- 5 Register the desired broadcast stations as your favorites, following the instructions on the computer's screen.**

Both broadcast stations not on the vTuner list and stations on the vTuner list can be registered. In this case they are registered on the receiver as favorite broadcast stations and can be played.

Listening to Pandora Internet Radio

Pandora is personalized internet radio that is designed to help you discover new music you'll love mixed in with music you already know.

For details, check the website: <http://www.pandora.com>

- You must have a registered account in order to listen to songs using Pandora Internet Radio. Select **PANDORA**, then follow the instructions on the screen to make the account settings.
- As of December 2012, the Pandora service is only offered in the United States.
- Some functions may be changed at Pandora's discretion.

Note

- When disposing of the product, we recommend you reset it to delete the data. See [Resetting the main unit on page 66](#).

Pandora®, the leading internet radio service, gives people music they love anytime, anywhere, through personalized radio stations.

Character entry operation using the virtual keyboard

- 1 Press TOOLS to switch to virtual keyboard operation mode.**
- 2 Use the directional keys $\uparrow/\downarrow/\leftarrow/\rightarrow$ to select the character/symbols and press ENTER.**
- 3 Repeat 2 above until character entry is finished and select OK from the virtual keyboard and press ENTER.**
 - To exit character entry using the virtual keyboard, press **TOOLS**.



About the Spotify audio stream playback function

Spotify is a music streaming distribution service managed and operated by Spotify Ltd. and distributing music over the Internet.

Spotify audio streams can be enjoyed using this unit and your smartphone or other mobile digital device.

Preparations (1) Installing the Spotify application on mobile digital devices and registering a Spotify Premium account

Important

- The Spotify application must be installed on mobile digital devices and you must have registered a Spotify Premium account (for a charge) in order to use the Spotify audio stream playback function on this unit. For registration procedures, see the Spotify website. <http://www.spotify.com/> <http://www.spotify.com/connect> For information on the countries and regions where Spotify services can be used, see the website below. <http://www.spotify.com/>

Spotify functions may be changed without notice.

An Internet connection is required on the mobile digital device in order to use the Spotify application. Using the mobile telephone line for the Internet connection tends to lead to high packet communication charges, so we recommend subscribing to a fixed packet rate plan. For details, contact your mobile telephone operator.

Preparations (2) Connecting this unit to the network

- Connect this unit to the network and also to the Internet. For instructions on connecting, see this unit's operating instructions.
- Connect the mobile digital device by Wi-Fi to the wireless LAN router of the same network as the one to which this unit is connected. For instructions on connecting, see the operating instructions of the mobile digital device and the wireless LAN router.

In order to use the Spotify audio stream playback function from the Spotify application

To use the Spotify audio stream playback function, select this unit on the Spotify application.

When Spotify audio streaming starts, this unit's input automatically switches to Spotify.

CAUTION

- Even if you are away from home, if you start Spotify audio streaming to play music on your mobile digital device and this unit is selected, the sound will be output from this unit. Depending on the volume level, the output may be loud, so be sure to check the audio output selection carefully before starting audio streaming. In addition, if you accidentally select this unit and play the sound on it, switch the audio output selection to the mobile digital device.

Note

- A separate contract with/payment to an Internet service provider is required to use the Spotify audio stream playback function.
- This unit's name is displayed as the playback device on the Spotify application. Also, this unit's name can be changed at "Friendly Name" in the network settings.
- When this unit is selected with the Spotify application, the account information is registered on this unit as well. When disposing of this unit, reset this unit's settings in order to delete the account information registered on this unit. For instructions on resetting, see this unit's operating instructions.

Playing back audio files stored on components on the network

This unit allows you to play music on media servers connected on an identical Local Area Network (LAN) as the receiver. This unit allows for the playing of files stored on the following devices:

- PCs running Microsoft Windows Vista or XP with Windows Media Player 11 installed
- PCs running Microsoft Windows 7 or 8 with Windows Media Player 12 installed
- DLNA-compatible digital media servers (on PCs or other components)

Playing back your favorite songs

Up to 64 favorite tracks on the media server and/or Internet radio stations can be registered in the Favorites folder. Note that only the audio files stored on components on the network can be registered.

Registering and deleting audio files and Internet radio stations in and from the Favorites folder

- Press **NET** to switch the remote control to the **M.SERVER** or **NETRADIO** operation mode.
- With the track or Internet radio station you want to register selected, press **+Fav**. The selected song or Internet radio station is then registered in the Favorite.

Note

- To delete a registered song, select the Favorites folder, select the song you want to delete from the folder, and press **CLR**. The selected song is then deleted from the Favorites folder.



The Network Setup menu

Setting up the network to listen to Internet radio on this receiver.

- 1 Press NET.**
- 2 Press HOME MENU.**
Network Setup menu appears on your TV. Use **↑/↓/←/→** and **ENTER** on the remote control to navigate through the screens and select menu items. Press **RETURN** to exit the current menu.
 - Press **HOME MENU** at any time to exit the Network Setup menu.
- 3 Select the setting you want to adjust.**
 - **Network Configuration**
 - **IP Address, Proxy** – Sets up the IP address/Proxy of this receiver (see below).
 - **Friendly Name** – The name of the receiver displayed on a computer or other device connected to the network can be changed (see below).
 - **Parental Lock** – Restricts usage of network functions ([page 47](#)).
 - **Language** – Language can be set the NETWORK function OSD screen ([page 47](#)).
 - **Firmware Update** – Use to update the receiver's firmware and check the version ([page 47](#)).
 - **Factory Reset** – Use to reset all network connection settings to their initial, factory-setting condition ([page 49](#)).
 - **System Info** – You can check the network settings of this receiver ([page 49](#)).

Network Configuration

IP address/Proxy setting

In case the router connected to the LAN terminal on this receiver is a broadband router (with a built-in DHCP server function), simply turn on the DHCP server function, and you will not need to set up the network manually. You must set up the network as described below only when you have connected this receiver to a broadband router without a DHCP server function. Before you set up the network, consult with your ISP or the network manager for the required settings. It is advised that you also refer to the operation manual supplied with your network component.

- **IP Address**
The IP address to be entered must be defined within the following ranges. If the IP address defined is beyond the following ranges, you cannot play back audio files stored on components on the network or listen to Internet radio stations.
Class A: 10.0.0.1 to 10.255.255.254
Class B: 172.16.0.1 to 172.31.255.254
Class C: 192.168.0.1 to 192.168.255.254
- **Subnet Mask**
In case an xDSL modem or a terminal adapter is directly connected to this receiver, enter the subnet mask provided by your ISP on paper. In most cases, enter 255.255.255.0.
- **Default Gateway**
In case a gateway (router) is connected to this receiver, enter the corresponding IP address.
- **Primary DNS Server/Secondary DNS Server**
In case there is only one DNS server address provided by your ISP on paper, enter it in the "**Primary DNS Server**" field. In case there are more than two DNS server addresses, enter "**Secondary DNS Server**" in the other DNS server address field.
- **Proxy Hostname/Proxy Port**
This setting is required when you connect this receiver to the Internet via a proxy server. Enter the IP address of your proxy server in the "**Proxy Hostname**" field. Also, enter the port number of your proxy server in the "**Proxy Port**" field.

- 1 Select 'Network Configuration' from the Network Setup menu.**

- 2 Select 'IP Address, Proxy' from the Network Configuration menu.**

- 3 Select the DHCP setting you want.**

When you select **ON**, the network is automatically set up, and you do not need to follow Steps 4. Proceed with Step 5.

If there is no DHCP server on the network and you select **ON**, this receiver will use its own Auto IP function to determine the IP address.

- The IP address determined by the Auto IP function is 169.254.X.X. You cannot listen to an Internet radio station if the IP address is set for the Auto IP function.

- 4 Enter the IP Address, Subnet Mask, Default Gateway, Primary DNS Server and Secondary DNS Server.**

Press **↑/↓** to select a number and **←/→** to move the cursor.

- 5 Select 'OFF' or 'ON' for the Enable Proxy Server setting to deactivate or activate the proxy server.**

In case you select **OFF**, proceed with Step 8. In case you select **ON**, on the other hand, proceed with Step 6.

- 6 Enter the address of your proxy server or the domain name.**

Use **↑/↓** to select a character, **←/→** to set the position, and **ENTER** to confirm your selection.

- 7 Enter the port number of your proxy server.**

Use **↑/↓** to select a character, **←/→** to set the position, and **ENTER** to confirm your selection.

- 8 Select 'OK' to confirm the IP Address/Proxy setup.**



Friendly Name

- 1** Select 'Network Configuration' from the Network Setup menu.
- 2** Select 'Friendly Name' from the Network Configuration menu.
- 3** Select 'Edit Name' then select 'Rename'.
If after changing the name you want to restore the name to the default, select **Default**.
- 4** Input the name you want.
Use **↑/↓** to select a character, **←/→** to set the position, and **ENTER** to confirm your selection.

Parental Lock

Set restrictions for using Internet services. Also set the password accompanying the usage restrictions.

- Upon shipment from the factory, the password is set to "0000".
- 1** Select 'Network Configuration' from the Network Setup menu.
 - 2** Select 'Parental Lock' from the Network Configuration menu.
 - 3** Input the password.
Use **↑/↓** to select a character, **←/→** to set the position, and **ENTER** to confirm your selection.
 - 4** Specify whether to turn Parental Lock on or off.
 - **OFF** – Internet services are not restricted.
 - **ON** – Internet services are restricted.
 - 5** If you want to change the password, select 'Change Password'.
In this case, the procedure returns to step 3.

Language

Language can be set on the NETWORK function OSD screen.

- 1** Select 'Language' from the Network Setup menu.
- 2** Select the language you want.
- 3** When you're finished, press **RETURN**.
You return to the Network Setup menu.

Firmware Update

Use this procedure to update the receiver's firmware. If an update file does not exist in the Pioneer's website, updating the firmware for the receiver is not necessary. Updating via a USB memory device is performed by downloading the update file from a computer, reading this file onto a USB memory device then inserting this USB memory device into the USB port on the receiver's front panel. With this procedure, the USB memory device containing the update file must first be inserted into the USB port on the receiver's front panel.

- If an update file is provided on the Pioneer website, download it onto your computer. When downloading an update file from the Pioneer website onto your computer, the file will be in ZIP format. Unzip the ZIP file before saving it on the USB memory device. If there are any old downloaded files or downloaded files for other models on the USB memory device, delete them.

Important

- Do NOT unplug the power cord during updating.
- Do not disconnect the USB memory device during updating.
- Verify the firmware version of the receiver in the **System Info** menu before updating and confirm that the firmware in the USB memory device is a newer version.
- Updating may reset the receiver's settings to the initial, factory-setting condition. Whether this is applicable to your receiver can be confirmed at our Pioneer website.

- 1** Select 'Firmware Update' from the Network Setup menu.

The receiver checks whether the USB memory device inserted into the USB port on the receiver's front panel contains updatable firmware.

- 2** To update, select 'Start'.

- 3** When 'Updating in progress, don't unplug!' is displayed, select 'Start'.

- If 'File Not Found' is displayed, try the following:
 - No update file was found on the USB memory device. Store the file in the USB memory device's root directory.
 - Try disconnecting then reconnecting the USB device or storing the update file again. If the error still occurs, try using a different USB memory device.

- 4** The firmware update will start. Please wait.

The OSD display will turn off during update and the words 'UPDATE' will flash on the front panel.

- 5** Will automatically restart after update is completed.

The screen will return automatically to the last selected function.

- If 'FAIL' or 'SUB FAIL' is displayed on the front panel display, updating has failed. Try the following:
 - If 'SUB FAIL' is displayed, please wait for a while. Update will start automatically. If update does not resume or if 'SUB FAIL' is displayed again, try the following.
 - Turn the receiver's power off, then turn it back on and try updating the firmware again.
 - Try disconnecting then reconnecting the USB device or storing the update file again. If the error still occurs, try using a different USB memory device.



Network setting using Safari browser

- 1 Launch Safari on your computer.
- 2 Press Bookmark icon. Click Bonjour list (a), and then select this receiver's name (Friendly Name) (b) in Bookmark.

If Bonjour list is not displayed, access the IP address "http://(the receiver's IP address)" from Safari.

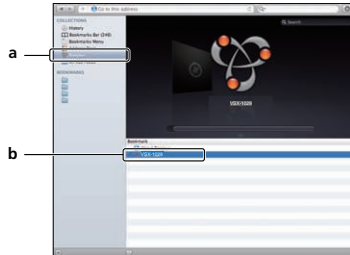

- 3 Select 'Network Setup'.

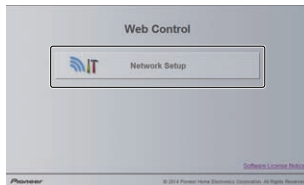

- 4 Click IP, Proxy Setting.

- 5 Setup the network settings manually and then press Apply.

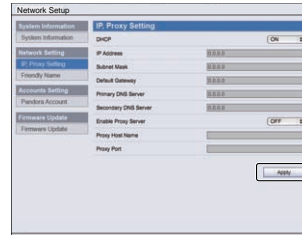

Note

- This setting for the network has been confirmed for Mac OS X 10.7 and Safari 5.1.

Friendly Name setting using Safari browser

- 1 Launch Safari on your computer.
- 2 Press Bookmark icon. Click Bonjour list (a), and then select this receiver's name (Friendly Name) (b) in Bookmark.
- 3 Select 'Network Setup'.



- 4 Click Friendly Name.
- 5 Enter friendly name and then press Apply.



Note

- This setting for the network has been confirmed for Mac OS X 10.7 and Safari 5.1.

Firmware update using Safari browser

- 1 Launch Safari on your computer.
- 2 Press Bookmark icon. Click Bonjour list (a), and then select this receiver's name (Friendly Name) (b) in Bookmark.
- 3 Select 'Network Setup'.



4 Click Firmware Update.

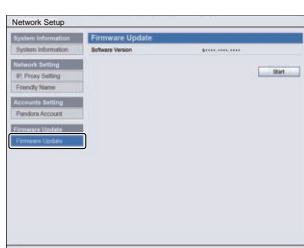

5 Press Start.

The firmware update prepare screen is displayed. If the screen does not switch automatically, click Click here.

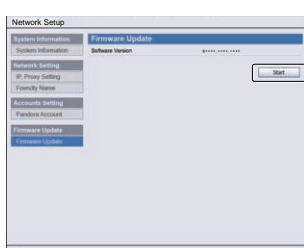

6 Browse the latest firmware on your computer (a) and then press Upload (b).

The extension of the firmware is fw. Please select a file that has the fw extension.

The confirmation screen is displayed. If you continue the firmware update, press OK. Once the firmware update process starts, you can't stop it. Wait until the file is uploaded (about one minute may be required depending on your LAN connection environment).

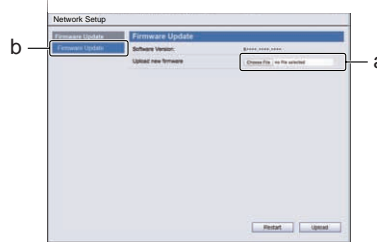

7 The firmware upload status screen is displayed.

"The upload process finished successfully." will be shown when the update is completed.

Unplug the power cord from the AC outlet after the update is completed.

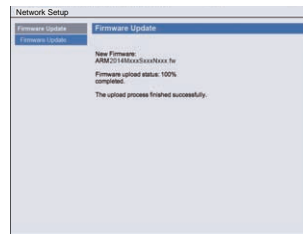

Factory Reset

Use to reset all network connection settings to their initial, factory-setting condition.

1 Select 'Factory Reset' from the Network Setup menu.

2 Select 'Start'.

3 Select 'OK' to confirm.

The screen will return automatically to the play screen.

System Information

The setting status of the following network-related items can be checked.

- IP Address – Check the IP address of this receiver.
- MAC Address – Check the MAC address of this receiver.
- Ver – Check the firmware version of this receiver.

1 Select 'System Info' from the Network Setup menu.

Display the setting status of the network-related items.

2 When you're finished, press RETURN.

You return to the Network Setup menu.

About network playback

The network playback function of this unit uses the following technologies:

Windows Media Player

See [Windows Media Player 11/Windows Media Player 12 on page 51](#) for more on this.

DLNA



DLNA CERTIFIED™ Audio Player

The Digital Living Network Alliance (DLNA) is a cross-industry organization of consumer electronics, computing industry and mobile device companies. Digital Living provides consumers with easy sharing of digital media through a wired or wireless network in the home.

The DLNA certification logo makes it easy to find products that comply with the DLNA Interoperability Guidelines. This unit complies with DLNA Interoperability Guidelines v1.5. When a PC running DLNA server software or other DLNA compatible device is connected to this player, some setting changes of software or other devices may be required. Please refer to the operating instructions for the software or device for more information.

DLNA™, the DLNA Logo and DLNA CERTIFIED™ are trademarks, service marks, or certification marks of the Digital Living Network Alliance.

Content playable over a network

- Even when encoded in a compatible format, some files may not play correctly.
- Movie or Photo files cannot be played back.
- There are cases where you cannot listen to an Internet radio station even if the station can be selected from a list of radio stations.
- Some functions may not be supported depending on the server type or version used.
- Supported file formats vary by server. As such, files not supported by your server are not displayed on this unit. For more information check with the manufacturer of your server.

Disclaimer for Third Party Content

ACCESS TO THIRD PARTY CONTENT SERVICES, INCLUDING ALL ASSOCIATED FEATURES AND FUNCTIONALITIES, IS PROVIDED "AS IS," "AS AVAILABLE" AND AT THE USER'S OWN RISK, WITHOUT WARRANTY OF ANY KIND. PIONEER DISCLAIMS ALL WARRANTIES, EXPRESS OR IMPLIED, IN CONNECTION WITH ACCESS TO AND USE OF CONTENT SERVICES THROUGH THIS DEVICE, INCLUDING WITHOUT LIMITATION WARRANTIES OF MERCHANTABILITY, SATISFACTORY QUALITY, FITNESS FOR A PARTICULAR PURPOSE, AND NON-INFRINGEMENT. PIONEER DOES NOT GUARANTEE, REPRESENT, OR WARRANT THAT CONTENT SERVICES WILL BE FREE FROM ERRORS, INTERRUPTION, LOSS, CORRUPTION, ATTACK, VIRUSES, INTERFERENCE, HACKING, OR OTHER SECURITY INTRUSION, AND PIONEER DISCLAIMS ANY LIABILITY IN CONNECTION WITH THE FOREGOING. PIONEER IS NOT LIABLE OR RESPONSIBLE FOR ANY LOSS OR DAMAGE ARISING FROM ACCESS TO OR USE OF CONTENT. NO ORAL OR WRITTEN INFORMATION OR ADVICE GIVEN BY PIONEER OR ITS CUSTOMER SERVICES REPRESENTATIVES WILL CREATE ANY SUCH WARRANTY.

IN NO EVENT WILL PIONEER, ITS AFFILIATES, OR THEIR RESPECTIVE OFFICERS, DIRECTORS, OR EMPLOYEES BE LIABLE IN CONNECTION WITH YOUR USE OF THIRD PARTY CONTENT SERVICES THROUGH THIS DEVICE FOR PERSONAL INJURY OR SPECIAL, INCIDENTAL, INDIRECT OR CONSEQUENTIAL DAMAGES OF ANY KIND, INCLUDING WITHOUT LIMITATION DAMAGES FOR ATTORNEY'S FEES, LOST DATA OR LOST PROFITS, REGARDLESS OF THE

THEORY OF LIABILITY AND WHETHER OR NOT ADVISED OF THE POSSIBILITY OF SUCH DAMAGES. IN NO EVENT WILL PIONEER'S TOTAL LIABILITY TO YOU FOR ALL DAMAGES ARISING FROM THE USE OR INABILITY TO USE THIRD PARTY CONTENT SERVICES (OTHER THAN AS MAY BE REQUIRED BY LAW IN CASES INVOLVING PERSONAL INJURY) EXCEED \$10.00. THE FOREGOING LIMITATIONS WILL APPLY EVEN IF THE ABOVE REMEDY FAILS OF ITS ESSENTIAL PURPOSE. IF ANY APPLICABLE AUTHORITY HOLDS ANY PORTION OF THIS SECTION TO BE UNENFORCEABLE, THEN LIABILITY WILL BE LIMITED TO THE MAXIMUM EXTENT PERMITTED BY APPLICABLE LAW.

About playback behavior over a network

- Playback may stall when the PC is switched off or any media files stored on it are deleted while playing content.
- If there are problems within the network environment (heavy network traffic, etc.) content may not be displayed or played properly (playback may be interrupted or stalled). For best performance, a 100BASE-TX connection between player and PC is recommended.
- If several clients are playing simultaneously, as the case may be, playback is interrupted or stalled.
- Depending on the security software installed on a connected PC and the setting of such software, network connection may be blocked.

Pioneer is not responsible for any malfunction of the player and/or the NETWORK features due to communication error/malfunctions associated with your network connection and/or your PC, or other connected equipment. Please contact your PC manufacturer or Internet service provider.

This product includes technology owned by Microsoft Corporation and cannot be used or distributed without a license from Microsoft Licensing, Inc.

Microsoft, Windows, Windows Media and Windows Vista are either registered trademarks or trademarks of Microsoft Corporation in the United States and/or other countries.



Glossary

FLAC

FLAC (Free Lossless Audio Codec) is an audio format that allows lossless audio. Audio is compressed in FLAC without any loss in quality. For more details about FLAC, visit the following website: <http://flac.sourceforge.net/>

vTuner

vTuner is a paid online database service that allows you to listen to radio and TV broadcasts on the Internet. vTuner lists thousands of stations from over 100 different countries around the globe. For more detail about vTuner, visit the following website:

<http://www.radio-pioneer.com>

"This product is protected by certain intellectual property rights of NEMS and BridgeCo. Use or distribution of such technology outside of this product is prohibited without a license from NEMS and BridgeCo or an authorized subsidiary."

Windows Media

Windows Media is a multimedia framework for media creation and distribution for Microsoft Windows. Windows Media is either a registered trademark or trademark of Microsoft Corporation in the U.S. and/or other countries. Use an application licensed by Microsoft Corporation to author, distribute, or play Windows Media formatted content. Using an application unauthorized by Microsoft Corporation is subject to malfunction.

Windows Media Player 11/Windows Media Player 12

Windows Media Player is software to deliver music, photos and movies from a Microsoft Windows computer to home stereo systems and TVs.

With this software, you can play back files stored on the PC through various devices wherever you like in your home.

This software can be downloaded from Microsoft's website.

- Windows Media Player 11 (for Windows XP or Windows Vista)
- Windows Media Player 12 (for Windows 7 or 8)

For more information check the official Microsoft website.

About playable file formats

The NETWORK feature of this receiver supports the following file formats. Note that some file formats are not available for playback although they are listed as playable file formats. Also, the compatibility of file formats varies depending on the type of server. Check with your server to ensure the compatibility of file formats supported by your server.

- Internet radio playback may be affected by the Internet communications environment, and in this case playback may not be possible even with the file formats listed here.
- With MP3, WAV, AAC, FLAC, AIFF and Apple Lossless files, when music files with the same format, sampling frequency, quantization bit number and number of channels are played successively, they are played with no gap.
 - Make sure the gap is at the minimum when using MP3 or AAC. If you are concerned about the gap, please use WAV or FLAC files.
 - Gapless playback is not possible when the format is being converted (transcoded) by the server.
 - Gapless playback is not possible in the DMR mode.



Music files

Extension	Stream	
MP3 (MPEG-1 Audio Layer 3)		
.mp3 ^a	Sampling frequency	32 kHz, 44.1 kHz, 48 kHz
	Quantization bitrate	16 bit
	Channel	2 ch
	Bitrate	8 kbps to 320 kbps
	VBR/CBR	Supported/Supported
WAV (LPCM)		
.wav	Sampling frequency	32 kHz, 44.1 kHz, 48 kHz, 88.2 kHz, 96 kHz, 176.4 kHz, 192 kHz
	Quantization bitrate	16 bit, 24 bit
	Channel	2 ch
WMA (WMA2/7/8/9)		
.wma ^b	Sampling frequency	32 kHz, 44.1 kHz, 48 kHz
	Quantization bitrate	16 bit
	Channel	2 ch
	Bitrate	5 kbps to 320 kbps
	VBR/CBR	Supported/Supported

AAC (MPEG-4 AAC LC, MPEG-4 HE AAC)		
.m4a .aac .3gp .3g2	Sampling frequency	32 kHz, 44.1 kHz, 48 kHz
	Quantization bitrate	16 bit
	Channel	2 ch
	Bitrate	16 kbps to 320 kbps
	VBR/CBR	Supported/Supported
FLAC		
.flac ^c	Sampling frequency	32 kHz, 44.1 kHz, 48 kHz, 88.2 kHz, 96 kHz, 176.4 kHz, 192 kHz
	Quantization bitrate	16 bit, 24 bit
	Channel	2 ch
AIFF		
.aif .aiff	Sampling frequency	32 kHz, 44.1 kHz, 48 kHz, 88.2 kHz, 96 kHz, 176.4 kHz, 192 kHz
	Quantization bitrate	16 bit, 24 bit
	Channel	2 ch
Apple Lossless		
.m4a .mp4	Sampling frequency	32 kHz, 44.1 kHz, 48 kHz, 88.2 kHz, 96 kHz
	Quantization bitrate	16 bit, 24 bit
	Channel	2 ch

- a. MPEG Layer-3 audio decoding technology licensed from Fraunhofer IIS and Thomson multimedia.
- b. Files encoded using Windows Media Codec 9 may be playable but some parts of the specification are not supported; specifically, Pro, Lossless, Voice.
- c. Uncompressed FLAC files are not supported. Pioneer does not guarantee playback.



Using the Home Menu

The following section shows you how to make detailed settings to specify how you're using the receiver, and also explains how to fine-tune individual speaker system settings to your liking.

Important

- The OSD will not appear if you have connected using the composite output to your TV. Use HDMI connection for Home Menu.
- If headphones are connected to the receiver, disconnect them.
- You can't use the Home Menu when the **NETRADIO**, **PANDORA**, **M.SERVER**, **FAVORITE**, **iPod/USB** or **ADAPTER** input is selected.

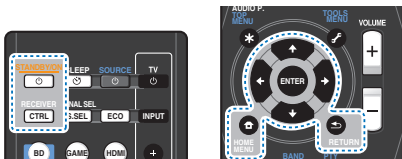

1 Switch on the receiver and your TV.

Press **STANDBY/ON** to switch on.

2 Switch the TV input to the input that connects this receiver to the TV through the corresponding HDMI cable.

3 Press RECEIVER, then press HOME MENU.

The Home Menu appears on your TV. Use **↑/↓/←/→** and **ENTER** on the remote control to navigate through the screens and select menu items. Press **RETURN** to exit the current menu.

- Press **HOME MENU** at any time to exit the Home Menu.

4 Select the setting you want to adjust.

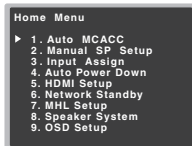

VSX-1029

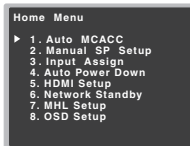

VSX-824

- **Auto MCACC** – This is a quick and effective automatic surround setup (see [Automatically setting up for surround sound \(MCACC\) on page 26](#)).
- **Manual SP Setup**
 - **Speaker Setting** – Specify the size and number of speakers you've connected (see below).
 - **X.Over** – Specify which frequencies will be sent to the subwoofer (page 54).
 - **Channel Level** – Adjust the overall balance of your speaker system (page 54).
 - **Speaker Distance** – Specify the distance of your speakers from the listening position (page 55).
- **Input Assign**
 - **Analog Input** – Specify what you've connected to the **ANALOG IN1** audio input (page 55).
 - **Component Input (VSX-1029 only)** – Specify what you've connected to the component video inputs (page 55).
- **Auto Power Down** – Sets to automatically turn off the power when the receiver has not operated for several hours (see [The Auto Power Down menu on page 56](#)).
- **HDMI Setup** – Set the audio return channel function or set the HDMI input signal to Standby through output or not during standby (see [HDMI Setup on page 59](#)).
- **Network Standby** – Allows the AirPlay function to be used even when the receiver is in the standby mode (see [The Network Standby menu on page 56](#)).
- **MHL Setup** – Changes the settings related to MHL (page 56).
- **Speaker System (VSX-1029 only)** – Specifies how you are using the speaker terminals (page 57).
- **OSD Setup** – Sets the overlay function **ON/OFF**.

Manual speaker setup

This receiver allows you to make detailed settings to optimize the surround sound performance. You only need to make these settings once (unless you change the placement of your current speaker system or add new speakers).

These settings are designed to fine-tune your system, but if you're satisfied with the settings made in [Automatically setting up for surround sound \(MCACC\) on page 26](#), it isn't necessary to make all of these settings.

Important

- *VSX-1029 only*: Depending on the **Speaker System** setting, there will be differences in the speaker items that can be adjusted. The OSD display for these operating instructions is an example of when the **Speaker System** setting is set to **Surr. Back**.

Speaker Setting

Use this setting to specify your speaker configuration (size, number of speakers). It is a good idea to make sure that the settings made in [Automatically setting up for surround sound \(MCACC\) on page 26](#) are correct.

1 Select 'Manual SP Setup' from the Home Menu.

2 Select 'Speaker Setting' from the Manual SP Setup menu.



3 Choose the set of speakers that you want to set then select a speaker size.

Use **←/→** to select the size (and number) of each of the following speakers:

- **Front** – Select **LARGE** if your front speakers reproduce bass frequencies effectively, or if you didn't connect a subwoofer. Select **SMALL** to send the bass frequencies to the subwoofer.
- **Center** – Select **LARGE** if your center speaker reproduces bass frequencies effectively, or select **SMALL** to send bass frequencies to the other speakers or subwoofer. If you didn't connect a center speaker, choose **NO** (the center channel is sent to the other speakers).
- **Front Height (VSX-1029 only)** – Select **LARGE** if your front height speakers reproduce bass frequencies effectively. Select **SMALL** to send bass frequencies to the other speakers or subwoofer. If you didn't connect front height speakers choose **NO**.
– You can only adjust the **Front Height** setting when **Pre Out Setting** is set to **Height**.
- **Surr** – Select **LARGE** if your surround speakers reproduce bass frequencies effectively. Select **SMALL** to send bass frequencies to the other speakers or subwoofer. If you didn't connect surround speakers choose **NO** (the sound of the surround channels is sent to the other speakers).
- **Surr. Back (VSX-1029 only)** – Select the number of surround back speakers you have (one, two or none). Select **LARGE** if your surround back speakers reproduce bass frequencies effectively. Select **SMALL** to send bass frequencies to the other speakers or subwoofer. If you didn't connect surround back speakers choose **NO**.
– *VSX-1029 only*: When using only one surround back speaker, connect it to the **SURROUND BACK L (Single)** terminals.
- **Subwoofer** – LFE signals and bass frequencies of channels set to **SMALL** are output from the subwoofer when **YES** is selected (see notes below). Choose the **PLUS** setting if you want the subwoofer to output bass sound continuously or you want deeper bass (the bass frequencies that would normally come out the front and center speakers are also routed to the subwoofer). If you did not connect a subwoofer choose **NO** (the bass frequencies are output from other speakers).

4 When you're finished, press RETURN.

You return to the Manual SP Setup menu.

Note

- If you select **SMALL** for the front speakers, the subwoofer will automatically be fixed to **YES**. Also, the center, surround, surround back and front height speakers (VSX-1029 only) can't be set to **LARGE** if the front speakers are set to **SMALL**. In this case, all bass frequencies are sent to the subwoofer.
- If the surround speakers are set to **NO**, the surround back speakers will automatically be set to **NO** (VSX-1029 only).
- If you have a subwoofer and like lots of bass, it may seem logical to select **LARGE** for your front speakers and **PLUS** for the subwoofer. This may not, however, yield the best bass results. Depending on the speaker placement of your room you may actually experience a decrease in the amount of bass due to low frequency cancellations. In this case, try changing the position or direction of speakers. If you can't get good results, listen to the bass response with it set to **PLUS** and **YES** or the front speakers set to **LARGE** and **SMALL** alternatively and let your ears judge which sounds best. If you're having problems, the easiest option is to route all the bass sounds to the subwoofer by selecting **SMALL** for the front speakers.

X.Over

- Default setting: **100Hz**

This setting decides the cutoff between bass sounds playing back from the speakers selected as **LARGE**, or the subwoofer, and bass sounds playing back from those selected as **SMALL**. It also decides where the cutoff will be for bass sounds in the LFE channel.

- For more on selecting the speaker sizes, see [Speaker Setting on page 53](#).

1 Select 'Manual SP Setup' from the Home Menu.

2 Select 'X.Over' from the Manual SP Setup menu.

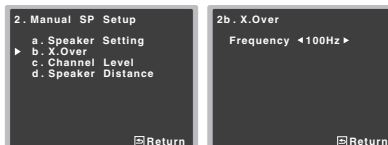

3 Choose the frequency cutoff point.

Frequencies below the cutoff point will be sent to the subwoofer (or **LARGE** speakers).

4 When you're finished, press RETURN.

You return to the Manual SP Setup menu.

Channel Level

Using the channel level settings, you can adjust the overall balance of your speaker system, an important factor when setting up a home theater system.

CAUTION

- The test tones used in the Channel Level settings are output at high volume.

1 Select 'Manual SP Setup' from the Home Menu.

2 Select 'Channel Level' from the Manual SP Setup menu.



3 Select a setup option.

- **Manual** – Move the test tone manually from speaker to speaker and adjust individual channel levels.
- **Auto** – Adjust channel levels as the test tone moves from speaker to speaker automatically.

4 Confirm your selected setup option.

The test tones will start after you press **ENTER**. After the volume increases to the reference level, test tones will be output.

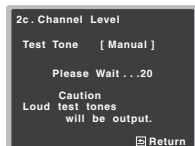

5 Adjust the level of each channel using \leftarrow/\rightarrow .

If you selected **Manual**, use \uparrow/\downarrow to switch speakers. The **Auto** setup will output test tones in the order shown on screen:

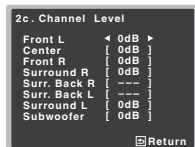

Adjust the level of each speaker as the test tone is emitted.

Note

- If you are using a Sound Pressure Level (SPL) meter, take the readings from your main listening position and adjust the level of each speaker to 75 dB SPL (C-weighting/slow reading).
- The subwoofer test tone is output at low volumes. You may need to adjust the level after testing with an actual soundtrack.

6 When you're finished, press **RETURN**.

You return to the Manual SP Setup menu.

Tip

- You can change the channel levels at any time by press **CH SEL** and **CH LEVEL +/-** on the remote control. You can also press **RECEIVER**, then press **CH SEL** and use \uparrow/\downarrow to select the channel, and then use \leftarrow/\rightarrow to adjust the channel levels.

Speaker Distance

For good sound depth and separation from your system, you need to specify the distance of your speakers from the listening position. The receiver can then add the proper delay needed for effective surround sound.

1 Select 'Manual SP Setup' from the Home Menu.

2 Select 'Speaker Distance' from the Manual SP Setup menu.

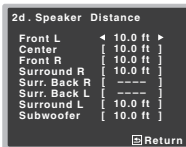
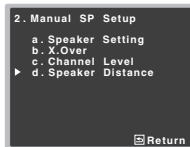

3 Adjust the distance of each speaker using \leftarrow/\rightarrow .

You can adjust the distance of each speaker in 0.1 feet increments.

4 When you're finished, press **RETURN**.

You return to the Manual SP Setup menu.

The Input Assign menu

Assigns input function for analog audio input terminal and component video input terminal (component video input terminal for VSX-1029 only).

- For the assignment of the digital signal inputs, see [Selecting the audio input signal on page 28](#).

Analog Input

ANALOG IN1 audio input terminal is assigned to **CD** under factory settings, but this can be changed to **TV** input.

1 Select 'Input Assign' from the Home Menu.

2 Select 'Analog Input' from the Input Assign menu.

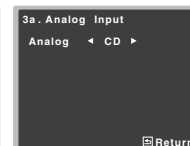
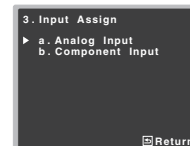

VSX-1029

3 Select the desired input option for the ANALOG IN1 audio input terminal.

4 When you're finished, press **RETURN**.

You return to the Input Assign menu.

Note

- When playing analog input audio, switch to the **CD** or **TV** input menu, press **RECEIVER** and press **SIGNAL SEL** several times to choose **A** (Analog) (see [Selecting the audio input signal on page 28](#)).

Component Input (VSX-1029 only)

COMPONENT VIDEO IN1 input terminal is assigned to **DVD** under factory settings, but this can be changed to **SAT/CBL** input.

1 Select 'Input Assign' from the Home Menu.

2 Select 'Component Input' from the Input Assign menu.



3 Select the desired input option for the COMPONENT VIDEO IN1 input terminal.

Select between **DVD**, **SAT/CBL** or **OFF**.

4 When you're finished, press RETURN.

You return to the Input Assign menu.

- Make sure you have connected the audio from the component to the corresponding inputs on the rear of the receiver.

The Auto Power Down menu

Set to automatically turn off the receiver after a specified time has passed (when the power has been on with no operation and no audio signal).

- Default setting: **OFF**

1 Select 'Auto Power Down' from the Home Menu.

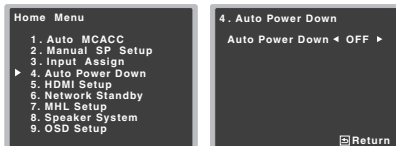

VSX-1029

2 Specify the amount of time to allow before the power is turned off (when there has been no operation).

- Select 15 minutes or 30 minutes, 60 minutes or OFF.

Important

- Auto power down will occur if the HDMI AUDIO PARAMETER is set to THRU and there is no operation.

- Even if images are being output, if the input volume level is exceptionally low, it will automatically turn OFF.
- Depending on the connected device, the static caused by the device may prevent the auto power down function from activating.
- If the input volume level is exceptionally low, in some cases the auto power down function may be activated.
- During photo viewer playback, continuing playback without performing any control operations will activate auto power down.

3 When you're finished, press RETURN.

You return to the Home Menu.

The Network Standby menu

This setting allows the AirPlay function for operating the receiver from a computer connected on the same LAN as the receiver to be used even when the receiver is in the standby mode.

1 Select 'Network Standby' from the Home Menu.

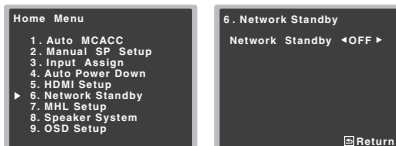

VSX-1029

2 Choose ON or OFF for the Network Standby.

- **ON** – The AirPlay function can be used even when the receiver is in the standby mode.
- **OFF** – The AirPlay function cannot be used when the receiver is in the standby mode (This lets you reduce power consumption in the standby mode).
 - If the **Network Standby** setting is set to **ON**, the power consumption during standby will increase.

3 When you're finished, press RETURN.

You return to the Home Menu.

The MHL Setup menu

Auto Switching

Select whether or not to switch the input automatically to the MHL input when an MHL-compatible device is connected.

Note

- This is only valid for MHL-compatible devices supporting this function.

1 Select 'MHL Setup' from the Home Menu.



VSX-1029

2 Select 'Auto Switching' from the MHL Setup menu.

3 Choose ON or OFF for the MHL Setup.

4 When you're finished, press RETURN.

You return to the Home Menu.

Setup ROKU standby mode

1 Select 'MHL Setup' from the Home Menu.

2 Select 'ROKU Standby' from the MHL Setup menu.

3 Use ←/→ to select the setting.

- **OFF** - When the receiver is in the standby mode, power is not provided to the Roku Streaming Stick. Energy consumption will decrease but it will take approximately 90 seconds for the images to be played back.
- **ON** - Will provide power to the Roku Streaming Stick even if the receiver is in the standby mode. Energy consumption will increase but will be able to immediately playback images.

Note

- Power will be supplied even if a MHL device is connected.

4 When you're finished, press RETURN.

You return to the Home Menu.

The Speaker System setting (VSX-1029 only)

Specify either using the surround back speaker (or the speaker B), or the front height speaker connection with the B-speaker terminals.

- Default setting: **Surr. Back**

1 Select 'Speaker System' from the Home Menu.**2 Select the speaker system setting using ←/→.**

- **Surr. Back** – Sound is output from the surround back speaker.
- **Height** – Sound is output from front height speaker.
- **SP-B** – Enables Speaker B to be installed in another room so that the sound of the stereo can be enjoyed elsewhere.
- **Bi-Amp** – Enables higher quality playback sound through the front speakers with the connection of bi-amp speakers.
- **ZONE 2** – In a separate room (subzone) from which the receiver is located (main zone), one can enjoy playback of a device connected to the receiver (multi-zone function).

3 When you're finished, press RETURN.

You return to the Home Menu.

The OSD Setup menu

Sets the overlay function **ON/OFF**.

1 Select 'OSD Setup' from the Home Menu.

VSX-1029

2 Choose ON or OFF for the OSD Setup.**3 When you're finished, press RETURN.**

You return to the Home Menu.



MULTI-ZONE listening

This receiver can power up to two independent systems in separate rooms after you have made the proper MULTI-ZONE connections.

Different sources can be playing in two zones at the same time or, depending on your needs, the same source can also be used. The main and sub zones have independent power (the main zone power can be off while the sub zone is on) and the sub zone can be controlled by the remote or front panel controls.

Making MULTI-ZONE connections

It is possible to make these connections if you have a separate speakers for your sub zone.

Note

- You can listen to the built-in tuner and other analog audio sources in the sub zone.
- You can't use sound controls (such as the bass/treble controls or Midnight listening) or any surround modes with a separate amplifier in the sub zone. You can, however, use the features available with your sub zone amplifier.
- Use this after selecting **ZONE 2** for [The Speaker System setting \(VSX-1029 only\) on page 57](#) on the Home Menu.

Connect a speaker to the SURROUND BACK/ZONE2 terminal on the rear of this receiver.

For details, see VSX-1029 connection diagram on [page 14](#).

You should have a pair of speakers attached to the sub zone amplifier as shown.

Using the MULTI-ZONE controls

The following steps use the front panel controls to select sources. See [MULTI-ZONE remote controls below](#).



1 Press CONTROL MULTI-ZONE ON/OFF button on the front panel.

The **ZONE** indicator lights when the MULTI-ZONE control has been switched ON.

- When the receiver is on, make sure that any operations for the sub zone are done while **ZONE** lights in the display. If this is not showing, the front panel controls affect the main zone only. If the receiver is in standby, the display is dimmed, and **ZONE** continues to light in the display.

2 Press CONTROL MULTI-ZONE ON/OFF button on the front panel.

Each press will switch between main zone and sub zone control.

- If no operation is performed for a few seconds, **MULTI-ZONE CONTROL** mode will automatically end.

3 Press INPUT SELECTOR dial to select the source for the zone you have selected.

For example, **Z2: DVD** sends the source connected to the **DVD** inputs to the sub room (**ZONE 2**).

- If you select **TUNER**, you can use the tuner controls to select a preset station (see [Saving station presets on page 36](#) if you're unsure how to do this). The tuner cannot be tuned to more than one station at a time. Therefore, changing the station in one zone also changes the station in the other zone. Please be careful not to change stations when recording a radio broadcast.

4 Use MASTER VOLUME dial to adjust the volume for the sub zone.

5 When you're finished, press CONTROL MULTI-ZONE ON/OFF again to return to the main zone controls.

You can also press **CONTROL MULTI-ZONE ON/OFF** button on the front panel to switch off all output to the sub zone.

Note

- You won't be able to switch the main zone off completely unless you've switched off the MULTI-ZONE control first.
- If you don't plan to use the MULTI-ZONE feature for a while, turn off the power in both the sub and main rooms so that this receiver is in standby.

MULTI-ZONE remote controls

With **[SHIFT]** button pressed, press the buttons below to operate the corresponding zone.

The following table shows the possible MULTI-ZONE remote controls:

Button	What it does
STANDBY/ON	Switches on/off power in the sub zone.
Input function buttons	Use to select the input source directly in the sub zone.
VOLUME +/-	Use to set the listening volume in the sub zone.
MUTE	Mutes the sound or restores the sound if it has been muted (adjusting the volume also restores the sound).



Control with HDMI function

Synchronized operations below with a **Control** with HDMI-compatible Pioneer TV or Blu-ray Disc player are possible when the component is connected to the receiver using an HDMI cable.

• Synchronized amp mode

The receiver's volume can be set and the sound can be muted using the TV's remote control.

• Power synchronization with TV

• Automatic switching of inputs

The receiver's input switches over automatically when the TV's input is changed and a **Control** with HDMI-compatible component is played.

📌 Important

- With Pioneer devices, the **Control** with HDMI functions are referred to as "KURO LINK".
- You cannot use this function with components that do not support **Control** with HDMI.
- We only guarantee this receiver will work with Pioneer made **Control** with HDMI-compatible components. However, we do not guarantee that all synchronized operations will work with components that support the **Control** with HDMI function.
- Use a High Speed HDMI®/™ Cable when you want to use the **Control** with HDMI function. The **Control** with HDMI function may not work properly if a different type of HDMI cable is used.
- For details about concrete operations, settings, etc., refer to also the operating instructions for each component.

Making Control with HDMI connections

You can use synchronized operation for a connected TV and other components.

- Be sure to connect the TV's audio cable to the audio input of this unit. When the TV and receiver are connected by HDMI connections, if the TV supports the HDMI Audio Return Channel function, the sound of the TV is input to the receiver via the HDMI terminal, so there is no need to connect an audio cable. In this case, set **ARC at HDMI Setup to ON** (see [HDMI Setup below](#)).

For details, see [Connecting using HDMI on page 20](#).

📌 Important

- When connecting this system or changing connections, be sure to switch the power off and disconnect the power cord from the wall socket.
After completing all connections, connect the power cords to the wall socket.
- After this receiver is connected to an AC outlet, a 2 second to 10 second HDMI initialization process begins. You cannot carry out any operations during initialization. The HDMI indicator on the display unit blinks during initialization, and you can turn this receiver on once it has stopped blinking.
- To get the most out of this function, we recommend that you connect your HDMI component not to a TV but rather directly to the HDMI terminal on this receiver.

HDMI Setup

You must adjust the settings of this receiver as well as the connected **Control** with HDMI-compatible components in order to make use of the **Control** with HDMI function. For more information see the operating instructions for each component.

1 Switch on the receiver and your TV.

Press **STANDBY/ON** to switch on.

2 Switch the TV input to the input that connects this receiver to the TV through the corresponding HDMI cable.

3 Press RECEIVER, then press HOME MENU.

The Home Menu appears on your TV. Use **↑/↓/←/→** and **ENTER** on the remote control to navigate through the screens and select menu items. Press **RETURN** to exit the current menu.

- Press **HOME MENU** at any time to exit the Home Menu.

4 Select 'HDMI Setup' from the Home Menu.



VSX-1029

5 Select the 'Control' setting you want.

Choose whether to set this unit's **Control** with HDMI function **ON** or **OFF**. You will need to set it to **ON** to use the **Control** with HDMI function.

When using a component that does not support the **Control** with HDMI function, set this to **OFF**.

- **ON** – Enables the **Control** with HDMI function. When this unit's power is turned off and you have a supported source begin playback while using the **Control** with HDMI function, the audio and video outputs from the HDMI connection are output from the TV.
- **OFF** – The **Control** with HDMI is disabled. Synchronized operations cannot be used. When this unit's power is turned off, audio and video of sources connected via HDMI are not output.
 - If the **Control** setting is not set to **OFF**, the power consumption during standby will increase.

6 Select the 'ARC' setting you want.

When a TV supporting the HDMI Audio Return Channel function is connected to the receiver, the sound of the TV can be input via the HDMI terminal.

- **ON** – The TV's sound is input via the HDMI terminal. This can only be selected when **Control** is set to **ON**.
- **OFF** – The TV's sound is input from the audio input terminals other than HDMI inputs.

7 Choose the 'Standby Through' setting you want.

When the receiver is in standby, the HDMI input signal selected here will be output to the TV by HDMI.

- **LAST** – The HDMI input signal selected previously will be output.

- **BD, DVD, SAT/CBL, MHL, HDMI, GAME** – The HDMI input signal selected here will be output.
- **OFF** – Signal will not be output during standby. (However, when **Control** is set to **ON**, the HDMI signal is transferred through by the **Control** with HDMI function even when in the standby mode.)
 - If the **Standby Through** setting is not set to **OFF**, the power consumption during standby will increase.
 - This setting can be used even with devices that are not compatible with the **Control** with HDMI function.
 - The **Standby Through** function cannot be used with MHL-compatible devices.

8 When you're finished, press RETURN.

You return to the Home Menu.

Before using synchronization

Once you have finished all connections and settings, you must:

- 1 Put all components into standby mode.
- 2 Turn the power on for all components, with the power for the TV being turned on last.
- 3 Choose the HDMI input to which the TV is connected to this receiver, and see if video output from connected components displays properly on the screen or not.
- 4 Check whether the components connected to all HDMI inputs are properly displayed.

About synchronized operations

The **Control** with HDMI-compatible component connected to the receiver operates in sync as described below.

- **Synchronized amp mode**
 - From the menu screen of the **Control** with HDMI-compatible TV, set audio to be played through this receiver, and the receiver will switch to the synchronized amp mode.
 - When in the synchronized amp mode, the synchronized amp mode is canceled when the receiver's power is turned off. To turn the synchronized amp mode back on, set audio to be played through the receiver from the TV's menu screen, etc. This receiver will power up and switch to the synchronized amp mode.
 - When in the synchronized amp mode, the synchronized amp mode is canceled if an operation that produces sound from the TV is performed from the TV's menu screen, etc.
 - When the synchronized amp mode is canceled, the receiver's power turns off if you were viewing an HDMI input or a TV program on the TV.
- **Power synchronization with TV**
 - When the TV's power is set to standby, the receiver's power is also set to standby. (Only when the input for a component connected to the receiver by HDMI connection is selected or when watching the TV.)
- **Automatic switching of inputs**
 - The receiver's input switches automatically when the **Control** with HDMI-compatible component is played.
 - The receiver's input switches automatically when the TV's input is switched.
 - The synchronized amp mode remains in effect even if the receiver's input is switched to a component other than one connected by HDMI.

Cautions on the Control with HDMI function

- Connect the TV and components (Blu-ray Disc player, etc.) directly to this receiver. Interrupting a direct connection with other amps or an AV converter (such as an HDMI switch) can cause operational errors.
- When the receiver's **Control** is turned **ON**, even if the receiver's power is in the standby mode, it is possible to output the audio and video signals from a player via HDMI to the TV without producing sound from the receiver, but

only when a **Control** with HDMI-compatible component (Blu-ray Disc player, etc.) and compatible TV are connected. In this case, the receiver's power turns on and the power and **HDMI** indicators light.



Troubleshooting

Incorrect operations are often mistaken for trouble and malfunctions. If you think that there is something wrong with this component, check the points below. Take a look at the other components and electrical appliances being used, because sometimes the problem may lie there. If the trouble isn't sorted out even after going through the checks below, ask your nearest Pioneer authorized independent service company to carry out repair work.

- If the unit does not operate normally due to external effects such as static electricity disconnect the power plug from the outlet and insert again to return to normal operating conditions.

General

❖ The power does not turn on.

- Disconnect the power plug from the outlet, and insert again.
- Make sure there are no loose strands of speaker wire touching the rear panel. This could cause the receiver to shut off automatically.

❖ The receiver suddenly switches off.

- When the Auto Power Down function is working, the power will automatically turn off if the receiver has not operated for several hours. Check the setting for the Auto Power Down function (see [The Auto Power Down menu on page 56](#)).
- After about a minute (you won't be able to switch the unit on during this time), switch the receiver back on. If the message persists, call a Pioneer authorized independent service company.

- If there is very little low frequency information in the source material, change your speaker settings to Front: SMALL / Subwoofer: YES, or Front: LARGE / Subwoofer: PLUS ([page 53](#)).

❖ The HDMI indicator blinks and the power does not turn on.

- The receiver may have a serious problem. Do not try switching the receiver on. Unplug the receiver from the wall and call a Pioneer authorized independent service company.

❖ The power suddenly turns on or off, or the input suddenly changes (When the Control with HDMI is ON).

- This happens because of the synchronized operation due to the Control with HDMI function. If synchronized operations are not needed, set the Control with HDMI to OFF (see [HDMI Setup on page 59](#)).

❖ OVERHEAT shows in the display and the power turns off.

- The temperature within the unit has exceeded the allowable value. Try moving the unit for better ventilation ([page 2](#)).
- Lower the volume level.

❖ TEMP shows in the display and the volume level drops.

- The temperature within the unit has exceeded the allowable value. Try moving the unit for better ventilation ([page 2](#)).
- Lower the volume level.

❖ No sound is output when an input function is selected.

- Use **VOLUME +/-** to turn up the volume.
- Press **MUTE** on the remote control to turn muting off.
- Press **SP-A/B** to select the proper speaker set (see [Switching the speaker terminal on page 18](#)).
- Set the **SIGNAL SEL** to **H** (HDMI), **C1/O1** (digital) or **A** (analog) according to the type of connections made ([page 28](#)).
- Make sure the component is connected correctly (refer to [Connecting your equipment on page 14](#)).
- Check the audio output settings of the source component.
- Refer to the instruction manual supplied with the source component.

❖ No image is output when an input function is selected.

- Make sure the component is connected correctly (refer to [Connecting your equipment on page 14](#)).
- Use the same type of video cables for the source component and TV to connect to this receiver (see [About video outputs connection on page 19](#)).
- **VSX-1029 only:** Check [The Input Assign menu on page 55](#) to make sure you're assigned the correct input.
- The video input selected on the TV monitor is incorrect. Refer to the instruction manual supplied with the TV.

❖ No sound from subwoofer.

- Make sure the subwoofer is switched on.
- If the subwoofer has a volume knob, make sure it's turned up.
- The Dolby Digital or DTS source you are listening to may not have an LFE channel.
- Switch the subwoofer setting in [Speaker Setting on page 53](#) to **YES** or **PLUS**.
- Switch the **LFE ATT (LFE Attenuate)** on [page 40](#) to **LFEATT 0** or **LFEATT 5**.

❖ No sound from surround or center speakers.

- Connect the speakers properly ([page 15](#)).
- Refer to [Speaker Setting on page 53](#) to check the speaker settings.
- Refer to [Channel Level on page 54](#) to check the speaker levels.

❖ The OSD screen (Home Menu, etc.) isn't displayed.

- The OSD will not appear if you have connected using the composite output to your TV. Use HDMI connection when setting up the system.

❖ The Phase Control feature doesn't seem to have an audible effect.

- If applicable, check that the lowpass filter switch on your subwoofer is off, or the lowpass cutoff is set to the highest frequency setting. If there is a PHASE setting on your subwoofer, set it to 0° (or depending on the subwoofer, the setting where you think it has the best overall effect on the sound).
- Make sure the speaker distance setting is correct for all speakers (see [Speaker Distance on page 55](#)).

❖ Considerable noise in radio broadcasts.

- Connect the antenna ([page 23](#)) and adjust the position for best reception.
- Route any loose cables away from the antenna terminals and wires.
- Fully extend the FM wire antenna, position for best reception, and secure to a wall (or connect an outdoor FM antenna).
- Connect an additional internal or external AM antenna ([page 23](#)).
- Turn off equipment causing interference or move it away from the receiver (or move antennas farther away from equipment causing noise).

❖ Broadcast stations cannot be selected automatically.

- Connect an outdoor antenna ([page 23](#)).

❖ Noise during playback of a cassette deck.

- Move the cassette deck away from your receiver, until the noise disappears.

❖ No sound is output or a noise is output when software with DTS is played back.

- Make sure the player's settings are correct and/or the DTS signal out is on. Refer to the instruction manual supplied with the DVD player.

❖ There seems to be a time lag between the speakers and the output of the subwoofer.

- See [Automatically setting up for surround sound \(MCACC\) on page 26](#) to set up your system again using MCACC (this will automatically compensate for a delay in the subwoofer output).

❖ After using the Auto MCACC setup, the speaker size setting (LARGE or SMALL) is incorrect.

- Low-frequency noise could have been caused by an air conditioner or motor. Switch off all appliances in the room and rerun the Auto MCACC setup.



❖ Can't operate the remote control.

- Replace the batteries (page 12).
- Operate within 7 m (23 ft.), 30° of the remote sensor (page 13).
- Remove the obstacle or operate from another position.
- Avoid exposing the remote sensor on the front panel to direct light.
- Press the remote control's **RECEIVER** button and switch to receiver control mode.

❖ The display is dark.

- Press **DIMMER** on the remote control repeatedly to return to the default.
- During ECO mode, the brightness switches between 2 levels. If the dimmest level is selected, DIMMER will be shown on the display. (Mode other than ECO: 4 levels, ECO mode: 2 levels)

❖ The receiver doesn't recognize iPod touch/iPhone.

- Try the following.
- 1. Simultaneously keep pressing the sleep button and home button on the iPod touch or iPhone for over 10 seconds to restart.
- 2. Turn on the receiver.
- 3. Connect the iPod touch/iPhone to the receiver.

❖ The Bluetooth wireless technology device cannot be connected or operated. Sound from the Bluetooth wireless technology device is not emitted or the sound is interrupted.

- Check that no object that emits electromagnetic waves in the 2.4 GHz band (microwave oven, wireless LAN device or Bluetooth wireless technology apparatus) is near the unit. If such an object is near the unit, set the unit far from it. Or, stop using the object emitting the electromagnetic waves.
- Check that the Bluetooth wireless technology device is not too far from the unit and that obstructions are not set between the Bluetooth wireless technology device and the unit. Set the Bluetooth wireless technology device and the unit so that the distance between them is less than about 10 m and no obstructions exist between them.
- Check that the Bluetooth ADAPTER and the **ADAPTER PORT** terminal of the unit are correctly connected.
- The Bluetooth wireless technology device may not be set to the communication mode supporting the Bluetooth wireless technology. Check the setting of the Bluetooth wireless technology device.
- Check that pairing is correct. The pairing setting was deleted from this unit or the Bluetooth wireless technology device. Reset the pairing.

- Check that the profile is correct. Use a Bluetooth wireless technology device that supports A2DP profile and AVRCP profile.

❖ Display flashes and cannot be operated.

- Depending on the input signal or listening mode, there may be functions that cannot be selected.

NETWORK feature

❖ Cannot access the network.

- The LAN cable is not firmly connected. Firmly connect the LAN cable (page 22).
- The router is not switched on. Switch on the router.
- Internet security software is currently installed in the connected component. There are cases where a component with Internet security software installed cannot be accessed.
- The audio component on the network which has been switched off is switched on. Switch on the audio component on the network before switching on this receiver.

❖ Playback does not start while 'Connecting Wired...' continues to be displayed.

- The component is currently disconnected from this receiver or the power supply. Check whether the component is properly connected to this receiver or the power supply.

❖ The PC or Internet radio is not properly operated.

- The corresponding IP address is not properly set. Switch on the built-in DHCP server function of your router, or set up the network manually according to your network environment (page 56).
- The IP address is being automatically configured. The automatic configuration process takes time. Please wait.

❖ The audio files stored on components on the network, such as a PC, cannot be played back.

- Windows Media Player 11 or Windows Media Player 12 is not currently installed on your PC. Install Windows Media Player 11 or Windows Media Player 12 on your PC.
- Audio files recorded in MPEG-4 AAC or FLAC are being played back on Windows Media Player 11 or Windows Media Player 12. Audio files recorded in MPEG-4 AAC or FLAC cannot be played back on Windows Media Player 11 or Windows Media Player 12. Try using another server. Refer to the operation manual supplied with your server.
- The component connected to the network is not properly operated.
 - Check whether the component is affected by special circumstances or is in the sleep mode.
 - Try rebooting the component if necessary.

- The component connected to the network does not permit file sharing. Try changing the settings for the component connected to the network.

- The folder stored on the component connected to the network has been deleted or damaged. Check the folder stored on the component connected to the network.

- Network connections could be restricted due to the computer's network settings, security settings, etc. Check the computer's network settings, security settings, etc.

- The audio files are copyrighted. DRM-protected audio files cannot be played back on this receiver.

❖ Cannot access the component connected to the network.

- The component connected to the network is not properly set. If the client is automatically authorized, you need to enter the corresponding information again. Check whether the connection status is set to "Do not authorize".

- There are no playable audio files on the component connected to the network. Check the audio files stored on the component connected to the network.

❖ Audio playback is undesirably stopped or disturbed.

- The audio file currently being played back was not recorded in a format playable on this receiver.
 - Check whether the audio file was recorded in a format supported by this receiver.
 - Check whether the folder has been damaged or corrupted.
 - Note that there are cases where even the audio files listed as playable on this receiver cannot be played back or displayed (page 51).

- The LAN cable is currently disconnected. Connect the LAN cable properly (page 22).

- There is heavy traffic on the network with the Internet being accessed on the same network. Use 100BASE-TX to access the components on the network.

- When in the DMR mode, depending on the external controller being used, playback may be interrupted when a volume operation is performed from the controller. In this case, adjust the volume from the receiver or remote control.

❖ There is a connection routed through a wireless LAN on the same network.

- There may be a shortage of bandwidth on the 2.4 GHz band used by the wireless LAN. Make wired LAN connections not routed through a wireless LAN.
- Install away from any devices emitting electromagnetic waves on the 2.4 GHz band (microwave ovens, game consoles, etc.). If this does not solve the problem, stop using other devices that emit electromagnetic waves.



❖ Cannot access Windows Media Player 11 or Windows Media Player 12.

- In case of Windows Media Player 11: You are currently logged onto the domain through your PC with Windows XP or Windows Vista installed. Instead of logging onto the domain, log onto the local machine (page 43).
- In case of Windows Media Player 12: You are currently logged onto the domain through your PC with Windows 7 or 8 installed. Instead of logging onto the domain, log onto the local machine (page 43).

❖ Cannot listen to Internet radio stations.

- The firewall settings for components on the network are currently in operation. Check the firewall settings for components on the network.
- You are currently disconnected from the Internet. Check the connection settings for components on the network, and consult with your network service provider if necessary (page 46).
- The broadcasts from an Internet radio station are stopped or interrupted. There are cases where you cannot listen to some Internet radio stations even when they are listed in the list of Internet radio stations on this receiver (page 44).

❖ The NETWORK function cannot be operated with the buttons on the remote control.

- The remote control is not currently set to the NETWORK mode. Press **NET** to set the remote control to the NETWORK mode (page 50).

❖ This unit cannot be selected from the Spotify application.

- An Internet connection is required for both the mobile digital device and this unit.
- Connect the mobile digital device by Wi-Fi to the wireless LAN router of the same network as the one to which this unit is connected.
- A Spotify Premium account (for a charge) must be registered on the Spotify application.
- When this unit is in standby, it cannot be selected from the Spotify application.

❖ The sound of the Spotify audio stream is not produced.

- Check whether this unit is selected on the Spotify application.
- Check that contents are playing on the Spotify application.
- If the above does not solve the problem, turn this unit's power off then back on.

❖ This unit's volume does not increase when the volume slider in the Spotify application is raised.

- On some models, there is an upper limit to the volume to prevent the volume from being too high accidentally. To raise

the volume higher in this case, do so by operating the remote control. When using an application such as iControlAV, the volume can also be increased from the application.

❖ Playback continues on this unit when the Spotify application is quit.

- The Spotify audio stream continues from this unit, even when the Spotify application is quit. To operate again, relaunch the Spotify application.

Troubleshooting of wireless LAN

❖ WLAN ERR shows in the display.

- There might be an irregularity with the WLAN adaptor connected to the DC OUTPUT for WIRELESS LAN on the rear panel.
- If WLAN ERR shows in the display when Network Standby is ON, please pull out the AC power cord. When the AC power cord is reconnected after 10 seconds, the WLAN ERR will be canceled.

❖ Network cannot be accessed via wireless LAN.

- Wireless LAN converter's power is not on (Wireless LAN converter's "Power", "WPS" and "Wireless" indicators are not all lit). Check that the USB cable connecting the wireless LAN converter to the receiver's DC OUTPUT for WIRELESS LAN terminal is properly connected.
- The LAN cable is not firmly connected. Firmly connect the LAN cable (page 22).
- Wireless LAN converter and base unit (wireless LAN router, etc.) are too far apart or there is an obstacle between them. Improve the wireless LAN environment by moving the wireless LAN converter and base unit closer together, etc.
- There is a microwave oven or other device generating electromagnetic waves near the wireless LAN environment.
 - Use the system in a place away from microwave ovens or other device generating electromagnetic waves.
 - Avoid using devices generating electromagnetic waves as much as possible when using the system with the wireless LAN.
- Multiple wireless LAN converters are connected to the wireless LAN router. When connecting multiple wireless LAN converters, their IP addresses must be changed. For example, if the wireless LAN router's IP address is "192.168.1.1", set the first wireless LAN converter's IP address to "192.168.1.249", the second wireless LAN converter's IP address to "192.168.1.248", using values between 2 and 249 (such as "249" and "248") that are not assigned to other wireless LAN converters or to other devices.

- Wireless LAN connections cannot be established between the wireless LAN converter and base unit (wireless LAN router, etc.).

- With the wireless LAN converter connected to the receiver, turn the receiver's power off, unplug the power cord from the power outlet, then plug the power cord back in and turn the receiver's power on.
- The wireless LAN converter must be set in order to establish wireless LAN connections. For details, refer to the operating instructions of the wireless LAN converter.

- The wireless LAN converter is properly connected to the receiver and the wireless LAN converter's indicators are lit, but the wireless LAN converter cannot be set from the receiver (the settings screen cannot be displayed).

If **Network Modes** in the receiver's **Network Settings** is set to **STATIC** and the IP address has been set manually, the IP address set in the wireless LAN converter may not match. In the receiver's **Network Settings**, set **Network Modes** to **DHCP**. After the setting is completed, turn the receiver's power off. Next, turn the receiver's power back on and check whether the wireless LAN converter's settings can be displayed with the receiver.

If the settings can be displayed, change the IP address settings of the receiver and wireless LAN converter as necessary.

- The IP address settings of the receiver and wireless LAN converter do not match the settings of the wireless LAN router, etc.

Check the IP address settings of the receiver and wireless LAN converter (including the **Network Modes**).

If the receiver's **Network Modes** is **DHCP**, turn the receiver's power off, then turn the power back on.

Check that the IP addresses of the receiver and wireless LAN converter match the settings of the wireless LAN router, etc. If the receiver's **Network Modes** is **STATIC**, set an IP address matching the network of the base unit (wireless LAN router, etc.).

For example, if the wireless LAN router's IP address is "192.168.1.1", set the receiver's IP address to "192.168.1.XXX" (*1), the subnet mask to "255.255.255.0", the gateway and DNS to "192.168.1.1".

Next, set the wireless LAN converter's IP address to "192.168.1.249" (*2).

(*1) Set the "XXX" in "192.168.1.XXX" to a number between 2 and 248 that is not assigned to other devices.

(*2) Set the "249" in "192.168.1.249" to a number between 2 and 249 that is not assigned to other devices.



- Try making the wireless LAN converter's advanced settings. The wireless LAN converter can be connected to a computer to make the advanced wireless LAN settings. For details, see the CD-ROM included for the wireless LAN converter. Check the settings of the wireless LAN router, etc., then change the settings of the wireless LAN converter.
Note, however, that making the advanced wireless LAN settings will not necessarily improve the wireless LAN environment. Be careful when changing the settings.
- The access point is set to conceal the SSID. In this case, the SSID may not be displayed on the access point list screen. If not, set the SSID, etc., by making the wireless LAN converter settings on the receiver manually.
- The access point's security settings use WEP 152-bit length code key or shared key authentication. The receiver does not support WEP 152-bit length code key or shared key authentication.
- Network connections cannot be established even when the above measures are taken. Reset the wireless LAN converter. After this, redo the wireless LAN converter's settings.
 - About resetting
 - 1. Check that the wireless LAN converter's power is on.
 - 2. Press the wireless LAN converter's reset button for at least 3 seconds.
 - 3. Release the reset button.
 When the wireless LAN converter is restarted, the resetting procedure is completed.

HDMI

- ❖ **No picture or sound.**
 - If the problem still persists when connecting your HDMI component directly to your monitor, please consult the component or monitor manual or contact the manufacturer for support.
- ❖ **No picture.**
 - Video signals that are input from the analog video terminal will not output from the HDMI terminal. Signals that are input from the HDMI terminal will not output from the analog video terminal. Be consistent with the type of cable between input and output.
 - Depending in the output settings of the source component, it may be outputting a video format that can't be displayed. Change the output settings of the source, or connect using the composite video jacks.
 - This receiver is HDCP-compatible. Check that the components you are connecting are also HDCP-compatible. If they are not, please connect them using the composite video jacks.

- Depending on the connected source component, it's possible that it will not work with this receiver (even if it is HDCP-compatible). In this case, connect using the composite video jacks between source and receiver.
- If video images do not appear on your TV, try adjusting the resolution, Deep Color or other setting for your component.
- To output signals in Deep Color, use an HDMI cable (High Speed HDMI®/™ Cable) to connect this receiver to a component or TV with the Deep Color feature.
- ❖ **No sound, or sound suddenly ceases.**
 - Check that the **HDMI** setting is set to **AMP** (page 39).
 - If the component is a DVI device, use a separate connection for the audio.
 - HDMI format digital audio transmissions require a longer time to be recognized. Due to this, interruption in the audio may occur when switching between audio formats or beginning playback.
 - Turning on/off the device connected to this unit's HDMI OUT terminal during playback, or disconnecting/connecting the HDMI cable during playback, may cause noise or interrupted audio.
- ❖ **Synchronized operation not possible using Control with HDMI function.**
 - Check the HDMI connections.
 - The cable may be damaged.
 - Select **ON** for the **Control** with HDMI setting (see [HDMI Setup on page 59](#)).
 - Turn the TV's power on before turning on this receiver's power.
 - Set the TV side Control with HDMI setting to on (see TV's operating instructions).

Important information regarding the HDMI connection

There are cases where you may not be able to route HDMI signals through this receiver (this depends on the HDMI equipped component you are connecting-check with the manufacturer for HDMI compatibility information).

If you aren't receiving HDMI signals properly through this receiver (from your component), please try the following configuration when connecting up.

Configuration

Connect your HDMI-equipped component directly to the display using an HDMI cable. Then use the most convenient connection (digital is recommended) for sending audio to the receiver. See the operating instructions for more on audio connections. Set the display volume to minimum when using this configuration.

Note

- Depending on the component, audio output may be limited to the number of channels available from the connected display unit (for example audio output is reduced to 2 channels for a monitor with stereo audio limitations).
- If you want to switch the input source, you'll have to switch functions on both the receiver and your display unit.
- Since the sound is muted on the display when using the HDMI connection, you must adjust the volume on the display every time you switch input sources.

Windows 8

This product is Windows 8.1 Compatible and Windows 9 Compatible.



Windows® and the Windows logo are trademarks of the Microsoft group of companies.



MHL



MHL, the MHL Logo, and Mobile High-Definition Link are trademarks or registered trademarks of MHL, LLC in the United States and other countries.

This receiver incorporates MHL 2.

HTC Connect



HTC, HTC Connect and the HTC Connect logo are trademarks of HTC Corporation.

About iPod/iPhone



AirPlay works with iPhone, iPad, and iPod touch with iOS 4.3.3 or later, Mac with OS X Mountain Lion, and Mac and PC with iTunes 10.2.2 or later.

USB works with iPhone 5s, iPhone 5c, iPhone 5, iPhone 4s, iPhone 4, iPhone 3GS, iPhone 3G, iPhone, iPod touch (1st through 5th generation) and iPod nano (3rd through 7th generation).

"Made for iPod" and "Made for iPhone" mean that an electronic accessory has been designed to connect specifically to iPod or iPhone, respectively, and has been certified by the developer to meet Apple performance standards. Apple is not responsible for the operation of this device or its compliance with safety and regulatory standards. Please note that the use of this accessory with iPod or iPhone may affect wireless performance.

Apple, AirPlay, iPad, iPhone, iPod, iPod nano, iPod touch, iTunes, Safari, Bonjour and Mac are trademarks of Apple Inc., registered in the U.S. and other countries. The AirPlay logo is a trademark of Apple Inc.

App Store is a service mark of Apple Inc.

Apple Lossless Audio Codec

Copyright © 2011 Apple Inc. All rights reserved.

Licensed under the Apache License, Version 2.0. You may obtain a copy of the License at <http://www.apache.org/licenses/LICENSE-2.0>.

About FLAC

FLAC Decoder

Copyright © 2000, 2001, 2002, 2003, 2004, 2005, 2006, 2007, 2008, 2009 Josh Coalson

Redistribution and use in source and binary forms, with or without modification, are permitted provided that the following conditions are met:

- Redistributions of source code must retain the above copyright notice, this list of conditions and the following disclaimer.
- Redistributions in binary form must reproduce the above copyright notice, this list of conditions and the following disclaimer in the documentation and/or other materials provided with the distribution.
- Neither the name of the Xiph.org Foundation nor the names of its contributors may be used to endorse or promote products derived from this software without specific prior written permission.

THIS SOFTWARE IS PROVIDED BY THE COPYRIGHT HOLDERS AND CONTRIBUTORS "AS IS" AND ANY EXPRESS OR IMPLIED WARRANTIES, INCLUDING, BUT NOT LIMITED TO, THE IMPLIED WARRANTIES OF MERCHANTABILITY AND FITNESS FOR A PARTICULAR PURPOSE ARE DISCLAIMED. IN NO EVENT SHALL THE FOUNDATION OR CONTRIBUTORS BE LIABLE FOR ANY DIRECT, INDIRECT, INCIDENTAL, SPECIAL, EXEMPLARY, OR CONSEQUENTIAL DAMAGES (INCLUDING, BUT NOT LIMITED TO, PROCUREMENT OF SUBSTITUTE GOODS OR SERVICES; LOSS OF USE, DATA, OR PROFITS; OR BUSINESS INTERRUPTION) HOWEVER CAUSED AND ON ANY THEORY OF LIABILITY, WHETHER IN CONTRACT, STRICT LIABILITY, OR TORT (INCLUDING NEGLIGENCE OR OTHERWISE) ARISING IN ANY WAY OUT OF THE USE OF THIS SOFTWARE, EVEN IF ADVISED OF THE POSSIBILITY OF SUCH DAMAGE.

About messages displayed when using network functions

Refer to the following information when you come up with a status message while operating the Network functions.

Status messages	Descriptions
Connection Down	The selected category or Internet radio station cannot be accessed.
File Format Error	Cannot be played back for some reasons.
Track Not Found	The selected song has not been found anywhere on the network.
Server Error	The selected server cannot be accessed.
Server Disconnected	The server has been disconnected.
Empty	There are no files stored in the selected folder.
License Error	The license for the contents to be played back is invalid.
Item Already Exists	This is displayed when the file you have attempted to register in the Favorites folder has already been registered.
Favorite List Full	This is displayed when you have attempted to register a file in the Favorites folder but the Favorites folder is already full.

Resetting the main unit

Use this procedure to reset all the receiver's settings to the factory default. Use the front panel controls to do this.

- For instructions on resetting the network connection settings, see [Factory Reset on page 49](#).

- 1 Switch the receiver into standby.**
- 2 While holding down BAND, press and hold  STANDBY/ON for about two seconds.**
- 3 When you see RESET? appear in the display, press AUTO SURROUND/STREAM DIRECT. OK? shows in the display.**
- 4 Press ALC/STANDARD SURR to confirm. OK appears in the display to indicate that the receiver has been reset to the factory default settings.**

Important

- If the **Control** with HDMI function is set to **ON**, the HDMI function's Standby Through is set to anything other than **OFF**, or the Network Standby is set to **ON**, you may not be able to reset the unit. In this case, reset either by turning **OFF** the **Control** with HDMI function, or by putting the unit into standby mode by turning off the power of all the connected devices, and resetting after the HDMI indicator on the front panel turns off.

Cleaning the unit

- Use a polishing cloth or dry cloth to wipe off dust and dirt.
- When the surface is dirty, wipe with a soft cloth dipped in some neutral cleanser diluted five or six times with water, and wrung out well, and then wipe again with a dry cloth. Do not use furniture wax or cleansers.
- Never use thinners, benzene, insecticide sprays or other chemicals on or near this unit, since these will corrode the surface.



VSX-1029



Manufactured under license from Dolby Laboratories. Dolby, Pro Logic, Surround EX, and the double-D symbol are trademarks of Dolby Laboratories.

VSX-824



Manufactured under license from Dolby Laboratories. Dolby, Pro Logic, and the double-D symbol are trademarks of Dolby Laboratories.

VSX-1029



For DTS patents, see <http://patents.dts.com>. Manufactured under license from DTS Licensing Limited. DTS, DTS-HD, the Symbol, & DTS and the Symbol together are registered trademarks, and DTS-HD Master Audio is a trademark of DTS, Inc. © DTS, Inc. All Rights Reserved.

VSX-824



For DTS patents, see <http://patents.dts.com>. Manufactured under license from DTS Licensing Limited. DTS, DTS-HD, the Symbol, & DTS and the Symbol together are registered trademarks of DTS, Inc. © DTS, Inc. All Rights Reserved.



Specifications

Amplifier section

Continuous average power output of 80 watts* per channel, min., at 8 ohms, from 20 Hz to 20 000 Hz with no more than 0.08 % total harmonic distortion.**

Front (stereo) 80 W + 80 W
Power output (1 kHz, 6 Ω, 1 %) 140 W per channel
Guaranteed speaker impedance 6 Ω to 16 Ω

* Measured pursuant to the Federal Trade Commission's Trade Regulation rule on Power Output Claims for Amplifiers

** Measured by Audio Spectrum Analyzer

Audio Section

Input (Sensitivity/Impedance)

LINE 200 mV/47 kΩ

Signal-to-Noise Ratio (IHF, short circuited, A network)

LINE 98 dB

Signal-to-Noise Ratio [EIA, at 1 W (1 kHz)]

LINE 79 dB

Video Section

Signal level

Composite 1 Vp-p (75 Ω)

Signal Level (VSX-1029)

Component Video

..... Y: 1.0 Vp-p (75 Ω), Pb/Pb: 0.7 Vp-p (75 Ω)

Corresponding maximum resolution (VSX-1029)

Component Video 1080p (1125p)

Tuner Section

Frequency Range (FM) 87.5 MHz to 108 MHz

Antenna Input (FM) 75 Ω unbalanced

Frequency Range (AM) 530 kHz to 1 700 kHz

Antenna (AM) Loop antenna

Digital In/Out Section

HDMI terminal Type A (19-pin)

HDMI output type 5 V, 100 mA

HDMI input/MHL terminal 5 V, 900 mA

USB terminal USB2.0 High Speed (Type A) 5 V, 1 A

iPod terminal USB

ADAPTER PORT terminal 5 V, 100 mA

Network Section

LAN terminal 10 BASE-T/100 BASE-TX

Integrated control section (VSX-1029)

Control (IR) terminal Ø 3.5 Mini-jack (MONO)

IR signal High Active (High Level: 2.0 V)

Miscellaneous

Power Requirements AC 120 V, 60 Hz

Power Consumption 520 W (VSX-1029)

450 W (VSX-824)

In standby 0.1 W

Dimensions

VSX-1029 435 mm (W) x 168 mm (H) x 342.5 mm (D)

17¹/₈ in. (W) x 6⁵/₈ in. (H) x 13¹/₂ in. (D)

VSX-824 435 mm (W) x 168 mm (H) x 331.5 mm (D)

17¹/₈ in. (W) x 6⁵/₈ in. (H) x 13¹/₁₆ in. (D)

Weight (without package) 9.2 kg (20 lb 5 oz) (VSX-1029)

8.6 kg (18 lb 6 oz) (VSX-824)

Furnished Parts

Microphone (for Auto MCACC setup) 1

Remote control 1

Dry cell batteries (AAA size IEC R03) 2

AM loop antenna 1

FM wire antenna 1

Warranty card 1

Quick start guide 1

Safety Brochure 1

SPEAKER CAUTION Sheet (English only) 1

These operating instructions (CD-ROM)

Note

- Specifications and the design are subject to possible modifications without notice, due to improvements.
- *This product includes FontAvenue® fonts licensed by NEC Corporation. FontAvenue is a registered trademark of NEC Corporation.*
- *Android and Google Play are trademarks of Google Inc.*

The Safety of Your Ears is in Your Hands

Get the most out of your equipment by playing it at a safe level – a level that lets the sound come through clearly without annoying blaring or distortion and, most importantly, without affecting your sensitive hearing. Sound can be deceiving. Over time, your hearing "comfort level" adapts to higher volumes of sound, so what sounds "normal" can actually be loud and harmful to your hearing. Guard against this by setting your equipment at a safe level BEFORE your hearing adapts.

ESTABLISH A SAFE LEVEL:

- Set your volume control at a low setting.
- Slowly increase the sound until you can hear it comfortably and clearly, without distortion.
- Once you have established a comfortable sound level, set the dial and leave it there.

BE SURE TO OBSERVE THE FOLLOWING GUIDELINES:

- Do not turn up the volume so high that you can't hear what's around you.
- Use caution or temporarily discontinue use in potentially hazardous situations.
- Do not use headphones while operating a motorized vehicle; the use of headphones may create a traffic hazard and is illegal in many areas.

5001a_A1_En



To register your product, find the nearest authorized service location, to purchase replacement parts, operating instructions, or accessories, please go to one of following URLs :

Pour enregistrer votre produit, trouver le service après-vente agréé le plus proche et pour acheter des pièces de rechange, des modes d'emploi ou des accessoires, reportez-vous aux URL suivantes :

In the USA/Aux Etats-Unis

<http://www.pioneerelectronics.com>

In Canada/Aux Canada

<http://www.pioneerelectronics.ca>

S018_B1_EnFr

© 2014 PIONEER HOME ELECTRONICS CORPORATION.
All rights reserved.

PIONEER HOME ELECTRONICS CORPORATION

1-1, Shin-ogura, Saiwai-ku, Kawasaki-shi, Kanagawa 212-0031, Japan

PIONEER ELECTRONICS (USA) INC.

P.O. BOX 1540, Long Beach, California 90801-1540, U.S.A. TEL: (800) 421-1404

PIONEER ELECTRONICS OF CANADA, INC.

340 Ferrier Street, Unit 2, Markham, Ontario L3R 2Z5, Canada TEL: 1-877-283-5901, 905-479-4411

PIONEER EUROPE NV

Haven 1087, Keetberglaan 1, B-9120 Melsele, Belgium TEL: 03/570.05.11

PIONEER ELECTRONICS ASIACENTRE PTE. LTD.

253 Alexandra Road, #04-01, Singapore 159936 TEL: 65-6472-7555

PIONEER ELECTRONICS AUSTRALIA PTY. LTD.

5 Arco Lane, Heatherton, Victoria, 3202, Australia, TEL: (03) 9586-6300

PIONEER ELECTRONICS DE MEXICO S.A. DE C.V.

Bldv.Manuel Avila Camacho 138 10 piso Col.Lomas de Chapultepec, Mexico, D.F. 11000 TEL: 55-9178-4270

K002_B3_En

<ARB7542-A>